

ASUS[®]

Motherboard

NCLV-D2
Series

NCLV-D2/SATA
NCLV-DS2

E2040

**First Edition V1
August 2005**

Copyright © 2005 ASUSTeK COMPUTER INC. All Rights Reserved.

No part of this manual, including the products and software described in it, may be reproduced, transmitted, transcribed, stored in a retrieval system, or translated into any language in any form or by any means, except documentation kept by the purchaser for backup purposes, without the express written permission of ASUSTeK COMPUTER INC. (“ASUS”).

Product warranty or service will not be extended if: (1) the product is repaired, modified or altered, unless such repair, modification or alteration is authorized in writing by ASUS; or (2) the serial number of the product is defaced or missing.

ASUS PROVIDES THIS MANUAL “AS IS” WITHOUT WARRANTY OF ANY KIND, EITHER EXPRESS OR IMPLIED, INCLUDING BUT NOT LIMITED TO THE IMPLIED WARRANTIES OR CONDITIONS OF MERCHANTABILITY OR FITNESS FOR A PARTICULAR PURPOSE. IN NO EVENT SHALL ASUS, ITS DIRECTORS, OFFICERS, EMPLOYEES OR AGENTS BE LIABLE FOR ANY INDIRECT, SPECIAL, INCIDENTAL, OR CONSEQUENTIAL DAMAGES (INCLUDING DAMAGES FOR LOSS OF PROFITS, LOSS OF BUSINESS, LOSS OF USE OR DATA, INTERRUPTION OF BUSINESS AND THE LIKE), EVEN IF ASUS HAS BEEN ADVISED OF THE POSSIBILITY OF SUCH DAMAGES ARISING FROM ANY DEFECT OR ERROR IN THIS MANUAL OR PRODUCT.

SPECIFICATIONS AND INFORMATION CONTAINED IN THIS MANUAL ARE FURNISHED FOR INFORMATIONAL USE ONLY, AND ARE SUBJECT TO CHANGE AT ANY TIME WITHOUT NOTICE, AND SHOULD NOT BE CONSTRUED AS A COMMITMENT BY ASUS. ASUS ASSUMES NO RESPONSIBILITY OR LIABILITY FOR ANY ERRORS OR INACCURACIES THAT MAY APPEAR IN THIS MANUAL, INCLUDING THE PRODUCTS AND SOFTWARE DESCRIBED IN IT.

Products and corporate names appearing in this manual may or may not be registered trademarks or copyrights of their respective companies, and are used only for identification or explanation and to the owners’ benefit, without intent to infringe.

Contents

Notices	vi
Safety information	vii
About this guide	viii
Typography	ix
NCLV-D2 Series specifications summary	x

Chapter 1: Product introduction

1.1	Welcome!	1-1
1.2	Package contents	1-1
1.3	Special features	1-2
1.3.1	Product highlights	1-2
1.3.2	Innovative ASUS features	1-4

Chapter 2: Hardware information

2.1	Before you proceed	2-1
2.2.1	Placement direction	2-2
2.2.2	Screw holes	2-2
2.2	Motherboard overview	2-2
2.2.3	Support kit for motherboard	2-3
2.2.4	Motherboard layouts	2-6
2.2.5	Layout contents	2-8
2.3	Central Processing Unit (CPU)	2-10
2.3.1	Installing the CPU	2-10
2.3.2	Installing the CPU heatsink and fan	2-12
2.4	System memory	2-14
2.4.1	Overview	2-14
2.4.2	Memory configurations	2-14
2.4.3	Installing a DIMM	2-16
2.4.4	Removing a DIMM	2-16
2.5	Expansion slots	2-17
2.5.1	Installing an expansion card	2-17
2.5.2	Configuring an expansion card	2-17
2.5.3	Interrupt assignments	2-18
2.5.4	PCI/PCI-X slots	2-19
2.5.5	PCI Express x8 slot	2-19
2.5.6	ZCR socket	2-19
2.6	Jumpers	2-20
2.7	Connectors	2-26
2.7.1	Rear panel connectors	2-26
2.7.2	Internal connectors	2-27

Contents

Chapter 3: Powering up

- 3.1 Starting up for the first time 3-1
- 3.2 Powering off the computer 3-2
 - 3.2.1 Using the OS shut down function 3-2
 - 3.2.2 Using the dual function power switch 3-2

Chapter 4: BIOS setup

- 4.1 Managing and updating your BIOS 4-1
 - 4.1.1 Creating a bootable floppy disk 4-1
 - 4.1.2 AFUDOS utility 4-2
 - 4.1.3 ASUS CrashFree BIOS 2 utility 4-5
 - 4.1.4 ASUS Update utility 4-7
- 4.2 BIOS setup program 4-10
 - 4.2.1 BIOS menu screen 4-11
 - 4.2.2 Menu bar 4-11
 - 4.2.3 Navigation keys 4-11
 - 4.2.4 Menu items 4-12
 - 4.2.5 Sub-menu items 4-12
 - 4.2.6 Configuration fields 4-12
 - 4.2.7 Pop-up window 4-12
 - 4.2.8 Scroll bar 4-12
 - 4.2.9 General help 4-12
- 4.3 Main menu 4-13
 - 4.3.1 System Time 4-13
 - 4.3.2 System Date 4-13
 - 4.3.3 Legacy Diskette A 4-13
 - 4.3.4 IDE Configuration 4-14
 - 4.3.5 Primary/Secondary IDE Master/Slave,
Tertiary and Fourth IDE Master 4-15
 - 4.3.6 System Information 4-16
- 4.4 Advanced menu 4-18
 - 4.4.1 CPU Configuration 4-18
 - 4.4.2 Chipset Configuration 4-20
 - 4.4.3 PCI/PnP Configuration 4-22
 - 4.4.4 Power Configuration 4-23
 - 4.4.5 USB Configuration 4-26
 - 4.4.6 Super IO Configuration 4-27
 - 4.4.7 Hardware Monitor 4-28
- 4.5 Server menu 4-30
 - 4.5.1 Remote Access Configuration 4-30

Contents

4.6	Security	4-32
4.7	Boot menu	4-35
4.7.1	Boot Device Priority	4-35
4.7.2	Boot Settings Configuration	4-36
4.8	Exit menu	4-37

Chapter 5: RAID configuration

5.1	Setting up RAID	5-1
5.1.1	RAID definitions	5-1
5.1.2	Installing hard disk drives	5-2
5.1.3	Setting the RAID item in BIOS	5-2
5.1.4	RAID configuration utilities	5-3
5.2	LSI Logic Embedded SATA RAID Setup Utility	5-4
5.2.1	Creating a RAID set	5-5
5.2.2	Adding or viewing a RAID configuration	5-11
5.2.3	Initializing the logical drives	5-14
5.2.4	Rebuilding failed drives	5-19
5.2.5	Checking the drives for data consistency	5-21
5.2.6	Deleting a RAID configuration	5-24
5.2.7	Selecting the boot drive from a RAID set	5-25
5.2.8	Enabling the WriteCache	5-26
5.3	Global Array Manager	5-26
5.4	Adaptec SCSISelect(TM) Utility (NCLV-DS2 model only) ...	5-27
5.4.1	Configuring the SCSI controller	5-28
5.4.2	Enabling the HostRAID controller	5-28
5.4.3	Creating a RAID 0 set (Stripe)	5-29
5.4.4	Creating a RAID 1 set (Mirror)	5-33
5.4.5	Creating a RAID 10 set (Stripe+Mirror)	5-36
5.4.6	Adding a spare drive to a RAID 10 set	5-40
5.4.7	Deleting a RAID 10 set spare drive	5-41
5.4.8	Deleting a RAID set	5-43
5.4.9	Rebuilding a RAID set	5-44
5.4.10	Verifying a RAID set hard disk drive	5-45
5.4.11	Making a RAID set bootable	5-46
5.5	Adaptec® RAID Configuration Utility (NCLV-D2/SATA model only)	5-48
5.5.1	Configuring the hard disk drive(s)	5-49
5.5.2	Creating a RAID 0 set (Striped)	5-50
5.5.3	Creating a RAID 0 set via Migrate	5-54
5.5.4	Creating a RAID 1 set (Mirrored)	5-56

Contents

5.5.5	Deleting a RAID 0 set	5-59
5.5.6	Deleting a RAID 1 set	5-60
5.5.7	Adding a spare drive to a RAID 1 set	5-62
5.5.8	Deleting a RAID 1 spare drive	5-63
5.5.9	Rebuilding a RAID set	5-64
5.5.10	Using the Disk Utilities	5-66

Chapter 6: Driver installation

6.1	RAID driver installation	6-1
6.1.1	Creating a RAID driver disk	6-1
6.1.2	Installing the RAID controller driver	6-3
6.2	LAN driver installation	6-10
6.2.1	Windows® 2000/2003 Server	6-10
6.2.2	Red Hat® Enterprise ver. 3.0	6-12
6.3	VGA driver installation	6-14
6.3.1	Windows® 2000 Server	6-14
6.3.2	Windows® 2003 Server	6-15
6.3.3	Red Hat® Enterprise ver. 3.0	6-15
6.4	Management applications and utilities installation	6-16
6.4.1	Running the support CD	6-16
6.4.2	Drivers menu	6-16
6.4.3	Management Software menu	6-17
6.4.4	Utilities menu	6-17
6.4.5	Contact information	6-17

Appendix: Block diagrams

A.1	NCLV-D2/SATA block diagram	A-1
A.2	NCLV-DS2 block diagram	A-2

Notices

Federal Communications Commission Statement

This device complies with Part 15 of the FCC Rules. Operation is subject to the following two conditions:

- This device may not cause harmful interference, and
- This device must accept any interference received including interference that may cause undesired operation.

This equipment has been tested and found to comply with the limits for a Class B digital device, pursuant to Part 15 of the FCC Rules. These limits are designed to provide reasonable protection against harmful interference in a residential installation. This equipment generates, uses and can radiate radio frequency energy and, if not installed and used in accordance with manufacturer's instructions, may cause harmful interference to radio communications. However, there is no guarantee that interference will not occur in a particular installation. If this equipment does cause harmful interference to radio or television reception, which can be determined by turning the equipment off and on, the user is encouraged to try to correct the interference by one or more of the following measures:

- Reorient or relocate the receiving antenna.
- Increase the separation between the equipment and receiver.
- Connect the equipment to an outlet on a circuit different from that to which the receiver is connected.
- Consult the dealer or an experienced radio/TV technician for help.



The use of shielded cables for connection of the monitor to the graphics card is required to assure compliance with FCC regulations. Changes or modifications to this unit not expressly approved by the party responsible for compliance could void the user's authority to operate this equipment.

Canadian Department of Communications Statement

This digital apparatus does not exceed the Class B limits for radio noise emissions from digital apparatus set out in the Radio Interference Regulations of the Canadian Department of Communications.

This class B digital apparatus complies with Canadian ICES-003.

Safety information

Electrical safety

- To prevent electrical shock hazard, disconnect the power cable from the electrical outlet before relocating the system.
- When adding or removing devices to or from the system, ensure that the power cables for the devices are unplugged before the signal cables are connected. If possible, disconnect all power cables from the existing system before you add a device.
- Before connecting or removing signal cables from the motherboard, ensure that all power cables are unplugged.
- Seek professional assistance before using an adapter or extension cord. These devices could interrupt the grounding circuit.
- Make sure that your power supply is set to the correct voltage in your area. If you are not sure about the voltage of the electrical outlet you are using, contact your local power company.
- If the power supply is broken, do not try to fix it by yourself. Contact a qualified service technician or your retailer.

Operation safety

- Before installing the motherboard and adding devices on it, carefully read all the manuals that came with the package.
- Before using the product, make sure all cables are correctly connected and the power cables are not damaged. If you detect any damage, contact your dealer immediately.
- To avoid short circuits, keep paper clips, screws, and staples away from connectors, slots, sockets and circuitry.
- Avoid dust, humidity, and temperature extremes. Do not place the product in any area where it may become wet.
- Place the product on a stable surface.
- If you encounter technical problems with the product, contact a qualified service technician or your retailer.

About this guide

This user guide contains the information you need when installing and configuring the motherboard.

How this guide is organized

This guide contains the following parts:

- **Chapter 1: Product introduction**
This chapter describes the features of the motherboard and the new technologies it supports.
- **Chapter 2: Hardware information**
This chapter lists the hardware setup procedures that you have to perform when installing system components. It includes description of the switches, jumpers, and connectors on the motherboard.
- **Chapter 3: Powering up**
This chapter describes the power up sequence and ways of shutting down the system.
- **Chapter 4: BIOS setup**
This chapter tells how to change system settings through the BIOS Setup menus. Detailed descriptions of the BIOS parameters are also provided.
- **Chapter 5: RAID configuration**
This chapter provides instructions for setting up, creating, and configuring RAID sets using the available utilities.
- **Chapter 6: Driver installation**
This chapter provides instructions for installing the necessary drivers for various system components.
- **Appendix: Reference information**
This appendix includes additional information that you may refer to when configuring the motherboard.

Where to find more information

Refer to the following sources for additional information and for product and software updates.

1. ASUS websites

The ASUS website provides updated information on ASUS hardware and software products. Refer to the ASUS contact information.

2. Optional documentation

Your product package may include optional documentation, such as warranty flyers, that may have been added by your dealer. These documents are not part of the standard package.

Conventions used in this guide

To make sure that you perform certain tasks properly, take note of the following symbols used throughout this manual.



DANGER/WARNING: Information to prevent injury to yourself when trying to complete a task.



CAUTION: Information to prevent damage to the components when trying to complete a task.



IMPORTANT: Instructions that you **MUST** follow to complete a task.



NOTE: Tips and additional information to help you complete a task.

Typography

Bold text

Indicates a menu or an item to select.

Italics

Used to emphasize a word or a phrase.

<Key>

Keys enclosed in the less-than and greater-than sign means that you must press the enclosed key.

Example: <Enter> means that you must press the Enter or Return key.

<Key1+Key2+Key3>

If you must press two or more keys simultaneously, the key names are linked with a plus sign (+).

Example: <Ctrl+Alt+D>

Command

Means that you must type the command exactly as shown, then supply the required item or value enclosed in brackets.

Example: At the DOS prompt, type the command line: **format A:/S**

NCLV-D2 Series specifications summary

CPU	Dual 604-pin sockets for Intel® Xeon™ processors with Extended Memory 64-bit Technology (EM64T) Supports Intel® Hyper-Threading Technology
Chipset	Northbridge : Intel® E7320 Memory Controller Hub (MCH) Southbridge : Intel® 6300ESB
Front Side Bus	800 MHz
Memory	Dual-channel memory architecture 6 x 240-pin DIMM sockets support registered ECC DDR2-400 memory modules Supports 256 MB up to 8 GB system memory
Expansion slots	1 x PCI-X 133 MHz/64-bit slot (PCI-X 1.0) (1U/2U riser) <i>(supports Zero-Channel RAID card)</i> 1 x PCI-X 133 MHz/64-bit slot (PCI-X 1.0) (1U/2U riser) 1 x PCI Express x8 slot (x4 link, PCI Express 1.0a) 2 x PCI 33 MHz/32-bit/5V slot (PCI 2.3) 1 x mini-PCI socket for ASUS® Server Management Board
Storage	Both models: Intel® 6300ESB Southbridge supports: <ul style="list-style-type: none"> - 4 x Ultra DMA 100/66/33 devices - 2 x SATA-150 HDDs with RAID 0 and RAID 1 configuration via the embedded LSI Logic Embedded SATA RAID controller
NCLV-D2/SATA	Adaptec® AIC-8130 PCI-X SATAII controller supports: <ul style="list-style-type: none"> - 4 x SATAII-300 HDDs with RAID 0, RAID 1, and RAID 0+1 configurations - Zero-Channel RAID card (optional)
NCLV-DS2	Adaptec® AIC-7901X PCI-X SCSI controller supports: <ul style="list-style-type: none"> - 1 x SCSI channel for up to 15 SCSI devices and RAID 0, RAID 1, and RAID 0+1 configurations - Zero-Channel RAID card (optional)
Graphics	ATI® RAGE-XL PCI-based VGA controller
LAN	LAN 1: Broadcom BCM5721 Gigabit LAN controller Complies with PCI Express 1.0a specifications LAN 2: Broadcom BCM5705E PCI Gigabit LAN controller Complies with PCI 2.3 specifications
USB	Intel® 6300ESB Southbridge supports: <ul style="list-style-type: none"> - 4 USB 2.0/1.1 ports (2 in rear and 2 in front panel)

(continued on the next page)

NCLV-D2 Series specifications summary

Special features	ASUS Smart Fan Control ASUS CrashFree BIOS 2 ASUS MyLogo2
BIOS features	AMI BIOS, 8 MB Flash ROM, Green, PnP, DMI2.0a, SMBIOS 2.3, WfM2.0
Rear panel	1 x PS/2 keyboard port (purple) 1 x PS/2 mouse port (green) 2 x USB 2.0/1.1 ports 1 x Serial port 1 x VGA port 2 x LAN (RJ-45) ports
Internal connectors	Floppy disk drive connector 2 x IDE connectors 2 x Serial ATA connectors (<i>both models</i>) 4 x Serial ATA RAID connectors (<i>NCLV-D2/SATA model only</i>) Ultra320 SCSI connector (<i>NCLV-DS2 model only</i>) USB 2.0/1.1 connector Serial port connector (COM2) 2 x CPU fan connectors 2 x front fan connectors 2 x rear fan connectors Baseboard Management Connector (BMC) Backplane SMBus connector Power supply SMBus connector Hard disk activity LED connector 24-pin SSI power connector 8-pin ATX 12V power connector System panel connector Auxiliary panel connector
Power Requirement	SSI power supply (with 24-pin and 8-pin 12V plugs) ATX 12V 2.0 compliant
Form Factor	E-ATX form factor: 12 in x 10.5 in (30.5 cm x 26.7 cm)
Support CD contents	Device drivers ASUS Live Update Utility ASUS Server Web-based Management (ASWM) Anti-virus software

**Specifications are subject to change without notice.*

This chapter describes the motherboard features and the new technologies it supports.

Product introduction



Chapter summary



1.1	Welcome!	1-1
1.2	Package contents	1-1
1.3	Special features	1-2

1.1 Welcome!

Thank you for buying an ASUS® NCLV-D2 Series motherboard!

The motherboard delivers a host of new features and latest technologies, making it another standout in the long line of ASUS quality motherboards!

Before you start installing the motherboard, and hardware devices on it, check the items in your package with the list below.

1.2 Package contents

Check your motherboard package for the following items.

Motherboard	ASUS NCLV-D2 Series motherboard
Cables	Serial ATA signal cables <ul style="list-style-type: none">• 2 pcs for NCLV-DS2 model• 6 pcs for NCLV-D2/SATA model Serial ATA power cable (dual-plug) <ul style="list-style-type: none">• 1 pc for NCLV-DS2 model• 3 pcs for NCLV-D2/SATA model SCSI Ultra320 cable (NCLV-DS2 model only) 80-conductor IDE cable 3-in-1 floppy disk drive cable
Accessories	2 x CEK springs (for CPUs) CPU heatsink support kit* I/O shield
Application CDs	ASUS motherboard support CD (includes ASWM)
Documentation	NCLV-D2 Series user guide ASWM 2.0 user guide



If any of the above items is damaged or missing, contact your retailer.

* Refer to the CPU heatsink support kit documentation for installation details.

1.3 Special features

1.3.1 Product highlights

Latest processor technology

The motherboard comes with dual 604-pin surface mount ZIF sockets designed for the Intel® Xeon™ processor with 800 MHz Front Side Bus (FSB) and 1 MB L2 cache. The processor incorporates the Intel® Hyper-Threading Technology, the Intel® NetBurst™ micro-architecture that features hyper-pipelined technology, and Extended Memory 64-bit Technology (EM64T). The EM64T enables the support for 64-bit operation system, such as 64-bit Windows® and Linux. See page 2-10 for details.

Intel® E7320 and Intel® 6300ESB chipset

The Intel® E7320 Memory Controller Hub (MCH) and the Intel® 6300ESB (I/O controller hub) provide the vital interfaces for the motherboard.

The MCH provides the processor, dual-channel DDR2-400 memory, and PCI Express interfaces. The ICH is a new generation server class I/O controller hub that provides the interface for PCI 2.3.

DDR2-400 memory support

The motherboard supports DDR2-400 memory which features data transfer rates of 400 MHz to meet the higher bandwidth requirements of the latest server applications. The dual-channel memory architecture doubles the bandwidth of your system memory to boost system performance, eliminating bottlenecks with peak bandwidths of up to 6.4 GB/s.

PCI Express™ interface

The motherboard fully supports PCI Express, the latest I/O interconnect technology that speeds up the PCI bus. PCI Express features point-to-point serial interconnections between devices and allows higher clockspeeds by carrying data in packets. This high speed interface is software compatible with existing PCI or PCI-X specifications. See page 2-19 for details.

Ultra320 SCSI feature (*NCLV-DS2 model only*)

The Adaptec® AIC-7901X PCI-X SCSI controller is onboard to support one 68-pin Ultra320 SCSI connector, that can connect up to 15 SCSI devices. See page 2-30 for details.

Serial ATA II feature (*NCLV-D2/SATA model only*)

The Adaptec® AIC-8130 SATA controller is onboard to support up to four SATA II hard disk drives with RAID 0, RAID 1, and RAID 10 configurations. The SATA II specification allows up to 300 MB/s data transfer rate. See page 2-29 for details.

Serial ATA technology



The motherboard supports the Serial ATA technology through the Serial ATA interfaces controlled by the Intel® 6300ESB. The SATA specification allows for thinner, more flexible cables with lower pin count, reduced voltage requirement, and up to 150 MB/s data transfer rate.

Built-in SATA RAID solution

The Intel® 6300ESB allows RAID 0 and RAID 1 configuration for two SATA connectors via the LSI Logic Embedded SATA RAID controller. See pages 2-28 and 5-4 for details.

Zero-Channel RAID (ZCR) solution

The motherboard comes with a 64-bit PCI-X slot for an optional Zero-Channel RAID card. The Zero-Channel RAID card allows you to create all types of RAID configurations for your storage devices. The ZCR capability provides a cost-effective, reliable, and high-performance RAID solution. See page 2-19 for details.

Gigabit LAN solution



The motherboard comes with dual Gigabit LAN controllers and ports to provide a total solution for your networking needs. The onboard Broadcom® BCM5721 and BCM5705E Gigabit LAN controllers use the PCI Express and PCI interfaces, respectively, and have network throughput close to Gigabit bandwidth. See page 2-26 for details.

USB 2.0 technology



The motherboard implements the Universal Serial Bus (USB) 2.0 specification, dramatically increasing the connection speed from the 12 Mbps bandwidth on USB 1.1 to a fast 480 Mbps on USB 2.0. USB 2.0 is backward compatible with USB 1.1. See pages 2-26 and 2-31 for details.

Temperature, fan, and voltage monitoring

The CPU temperature is monitored by the ASIC (integrated in the Winbond hardware monitor) to prevent overheating and damage. The system fan rotations per minute (RPM) is monitored for timely failure detection. The ASIC monitors the voltage levels to ensure stable supply of current for critical components. See page 4-28 for details.

1.3.2 Innovative ASUS features

CrashFree BIOS 2

This feature allows you to restore the original BIOS data from the support CD in case when the BIOS codes and data are corrupted. This protection eliminates the need to buy a replacement ROM chip. See page 4-5 for details.

ASUS Smart Fan Control technology



The ASUS Smart Fan Control technology smartly adjusts the fan speeds according to the system loading to ensure quiet, cool, and efficient operation. See page 4-28 for details.

ASUS MyLogo2™

This new feature present in the motherboard allows you to personalize and add style to your system with customizable boot logos. See page 4-36 for details.

This chapter lists the hardware setup procedures that you have to perform when installing system components. It includes description of the jumpers and connectors on the motherboard.

Hardware information



Chapter summary



2.1	Before you proceed	2-1
2.2	Motherboard overview	2-2
2.3	Central Processing Unit (CPU)	2-10
2.4	System memory	2-14
2.5	Expansion slots	2-17
2.6	Jumpers	2-20
2.7	Connectors	2-26

2.1 Before you proceed

Take note of the following precautions before you install motherboard components or change any motherboard settings.



- Unplug the power cord from the wall socket before touching any component.
- Use a grounded wrist strap or touch a safely grounded object or to a metal object, such as the power supply case, before handling components to avoid damaging them due to static electricity.
- Hold components by the edges to avoid touching the ICs on them.
- Whenever you uninstall any component, place it on a grounded antistatic pad or in the bag that came with the component.
- **Before you install or remove any component, ensure that the power supply is switched off or the power cord is detached from the power supply.** Failure to do so may cause severe damage to the motherboard, peripherals, and/or components.

Onboard LED

The motherboard comes with a standby power LED. The green LED lights up to indicate that the system is ON, in sleep mode, or in soft-off mode. This is a reminder that you should shut down the system and unplug the power cable before removing or plugging in any motherboard component. The illustration below shows the location of the onboard LED.

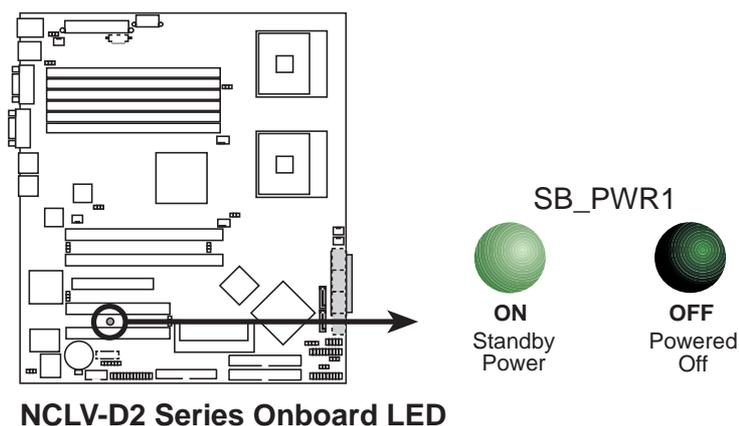

2.2 Motherboard overview

Before you install the motherboard, study the configuration of your chassis to ensure that the motherboard fits into it.

To optimize the motherboard features, we highly recommend that you install it in an **SSI EEB 3.5 compliant chassis**.



Make sure to unplug the chassis power cord before installing or removing the motherboard. Failure to do so can cause you physical injury and damage motherboard components!

2.2.1 Placement direction

When installing the motherboard, make sure that you place it into the chassis in the correct orientation. The edge with external ports goes to the rear part of the chassis as indicated in the image below.

2.2.2 Screw holes

Place nine (9) screws into the holes indicated by circles to secure the motherboard to the chassis.



Do not overtighten the screws! Doing so can damage the motherboard.

Place this side towards
the rear of the chassis

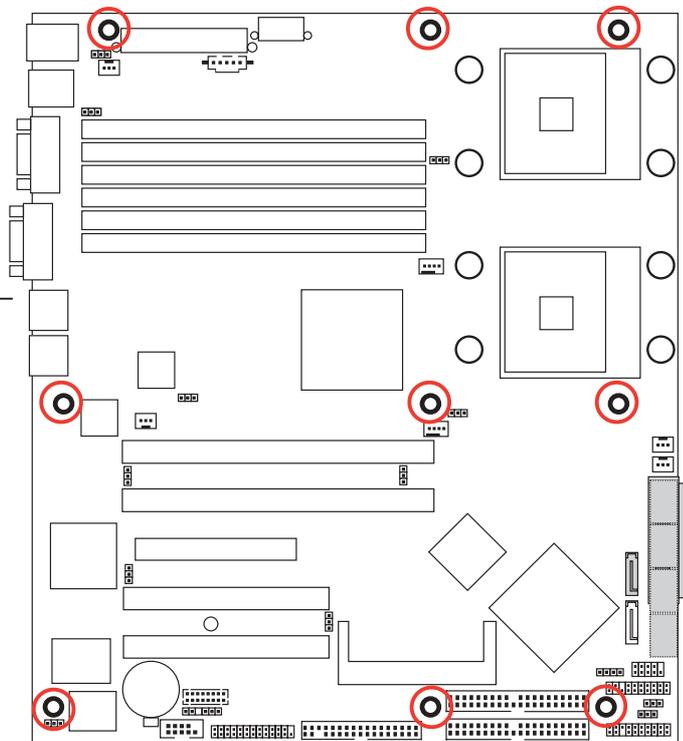

2.2.3 Support kit for motherboard

For additional protection from motherboard breakage due to the weight of the CPU heatsinks, your motherboard package comes with two CEK springs. Install the CEK spring before installing the motherboard to the chassis.



If your chassis is **SSI EEB 3.5 compliant**, we recommend that you use the CEK springs.

CEK spring

Each CEK spring has four hooks to match the designated holes around the CPU area.

Hook



To install the CEK spring:

1. Locate the CPU heatsink holes on the motherboard.

Socket for CPU2

Socket for CPU1

Heatsink hole

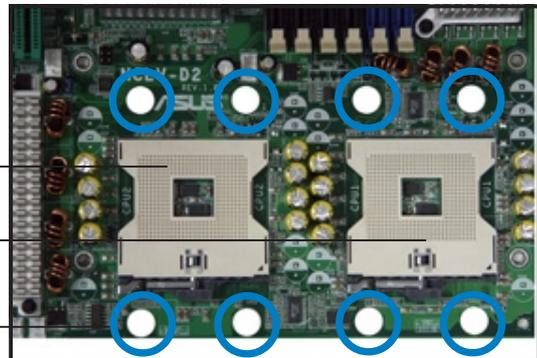

2. Position the CEK spring underneath the motherboard, then match the CEK spring hooks to the CPU1 heatsink holes.

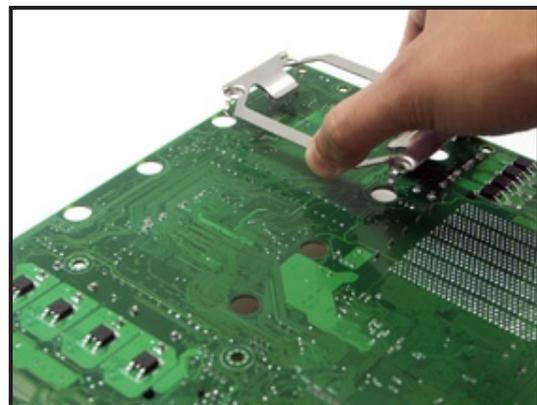

3. Insert the hooks on one side of the spring to the heatsink holes.

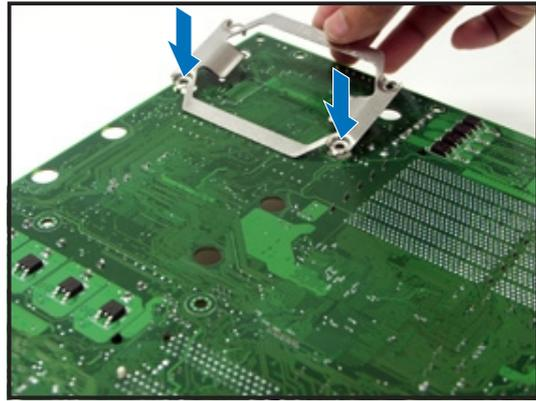

4. Push the hooks on the other side of the spring inward until they snap in place.

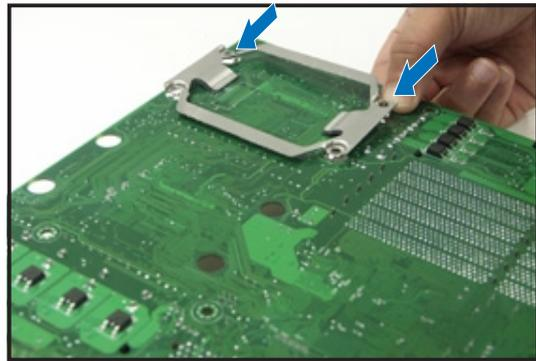

5. If you installed a second CPU, repeat steps 2 to 4 to install the CEK spring to the CPU2 heatsink holes.

The CEK springs appear as shown when installed.

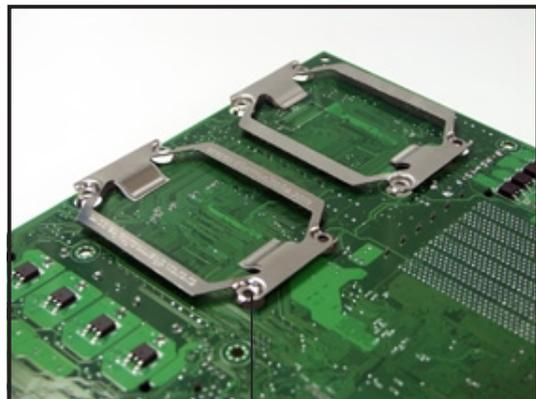

CEK spring screw hole

6. Before installing the motherboard into the chassis, locate the standoffs that should match the eight (8) CEK spring screw holes.

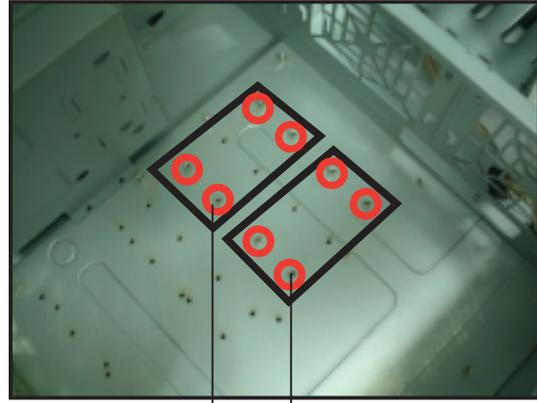

Standoffs for CPU1

Standoffs for CPU2

7. Install the motherboard with the external I/O ports toward the chassis rear panel. The CPU sockets should be right on top of their respective standoffs.



Socket for CPU1

Socket for CPU2



Make sure that the standoffs perfectly match the CEK spring screw holes; otherwise, you can not install the CPU heatsinks properly.

8. Secure the motherboard with 9 screws. Refer to section “2.2.2 Screw holes” for illustration.

2.2.4 Motherboard layouts

NCLV-D2/SATA model

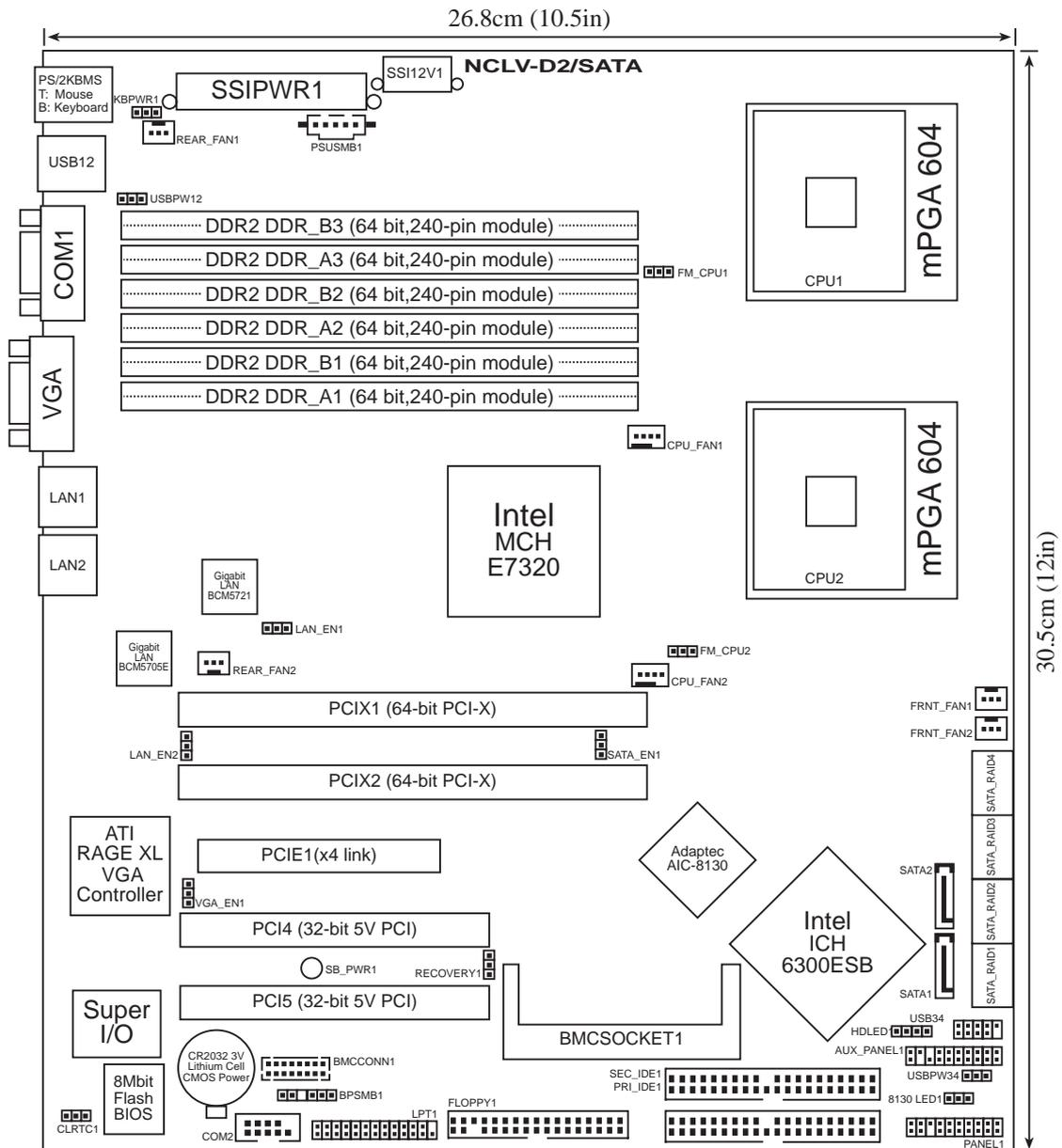

NCLV-DS2 model

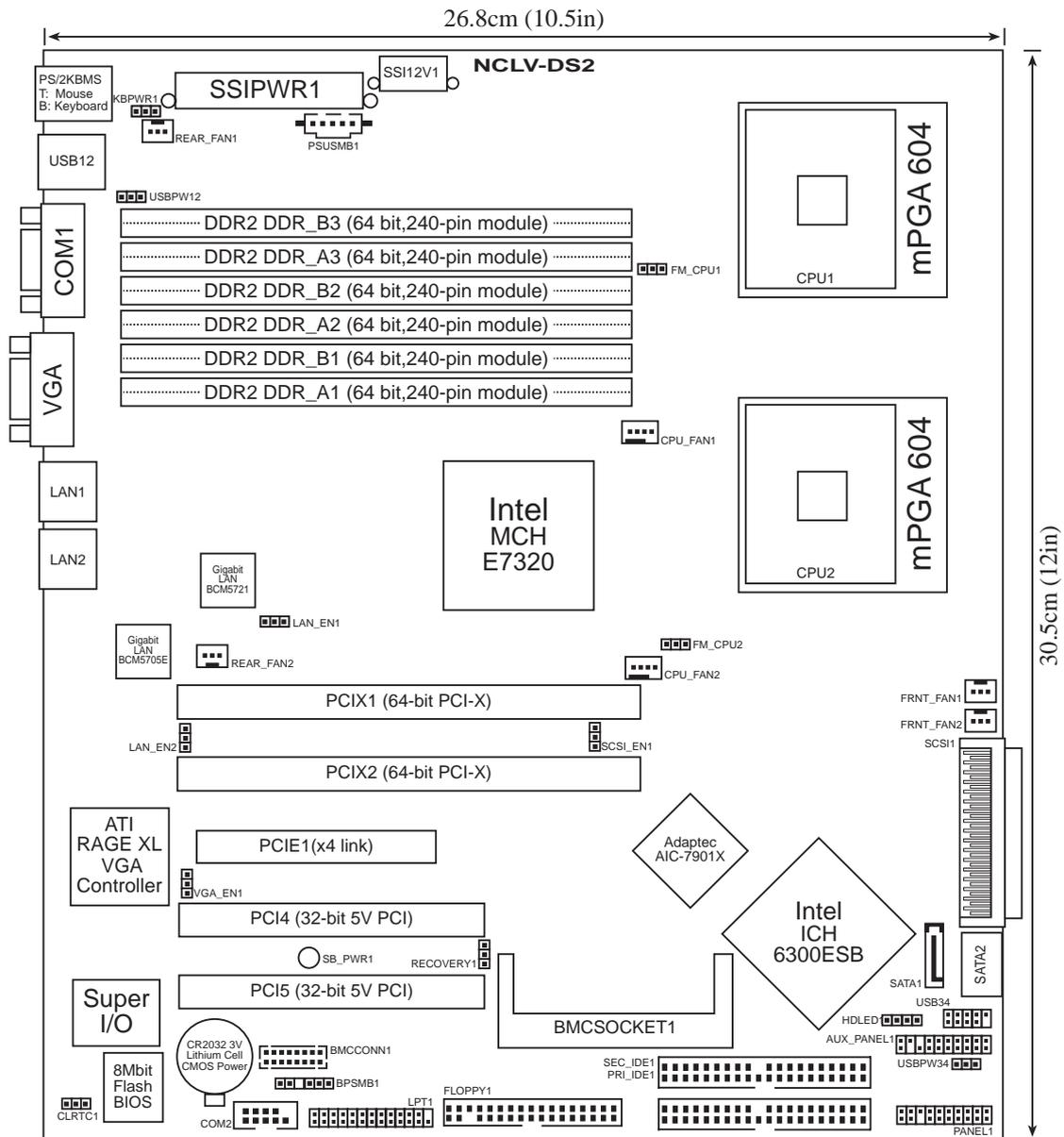

2.2.5 Layout contents

Slots/Sockets	Page
1. CPU sockets	2-10
2. DDR2 DIMM sockets	2-14
3. PCI/PCI-X/PCI Express slots	2-19
4. Zero-Channel RAID socket	2-19

Jumpers	Page
1. Clear RTC RAM (CLRTC1)	2-20
2. CPU fan pin selection (3-pin FM_CPU1, FM_CPU2)	2-21
3. USB device wake-up (3-pin USBPW12, USBPW34)	2-21
4. Keyboard power (3-pin KBPWR1)	2-22
5. VGA controller setting (3-pin VGA_EN1)	2-22
6. Gigabit LAN controller setting (3-pin LAN1_EN1)	2-23
7. Gigabit LAN controller setting (3-pin LAN2_EN1)	2-23
8. SCSI controller setting (3-pin SCSI_EN1)	2-24
9. SATA controller setting (3-pin SATA_EN1)	2-24
10. Adaptec 8130 LED setting (3-pin LED1)	2-25
11. Force BIOS recovery setting (3-pin RECOVERY1)	2-25

Rear panel connectors	Page
1. PS/2 mouse port (green)	2-26
2. PS/2 keyboard port (purple)	2-26
3. USB 2.0 ports 1 and 2	2-26
4. Serial (COM1) port	2-26
5. VGA port	2-26
6. Gigabit LAN (RJ-45) ports	2-26

Internal connectors	Page
1. Floppy disk drive connector (34-1 pin FLOPPY1)	2-27
2. Primary IDE connectors (40-1 pin PRI_IDE, SEC_IDE)	2-27
3. Serial ATA connectors (7-pin SATA1, SATA2)	2-28
4. Serial ATA RAID connectors (two 68-pin SCSI A1, SCSI B1)	2-29
5. Hard disk activity LED connector (4-pin HDLED1)	2-29
6. Ultra320 SCSI connectors	2-30
7. USB connector (10-1 pin USB34)	2-31
8. Serial port connector (10-1 pin COM2)	2-31
9. CPU and system fan connectors (3-pin CPU_FAN1/2, REAR_FAN1/2, FRNT_FAN1/2)	2-32
10. BMC connector (16-pin BMCCONN1)	2-32
11. Backplane SMBus connector (6-1 pin BPSMB1)	2-33
12. Power supply SMBus connector (5-pin PSUSMB1)	2-33
13. ATX power connectors (24-pin ATXPWR1, 8-pin ATX12V1)	2-34
14. System panel connector (20-pin PANEL1)	2-35
15. Auxiliary panel connector (20-pin AUX_PANEL1)	2-36

2.3 Central Processing Unit (CPU)

The motherboard comes with surface mount 604-pin Zero Insertion Force (ZIF) sockets. The sockets are designed for the Intel® Xeon™ processor in the 604-pin package with 1 MB L2 cache. The new generation Xeon™ processor supports 800 MHz system bus and Extended Memory 64-bit Technology (EM64T).

2.3.1 Installing the CPU

To install a CPU:

1. Locate the CPU sockets on the motherboard.

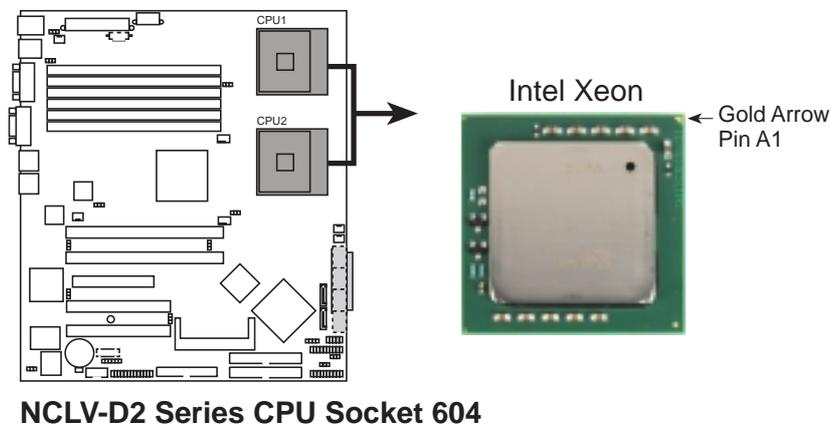

If installing only one CPU, use the socket CPU1.

2. Flip up the socket lever and push it all the way to the other side.



Make sure that the socket lever is pushed back all the way, otherwise the CPU does not fit in completely.

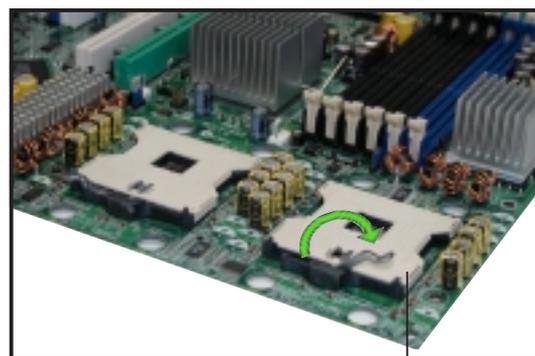

Socket for CPU1

3. Position the CPU above the socket as shown.
4. Carefully insert the CPU into the socket until it fits in place.



The CPU fits only in one correct orientation. DO NOT force the CPU into the socket to prevent bending the pins and damaging the CPU!

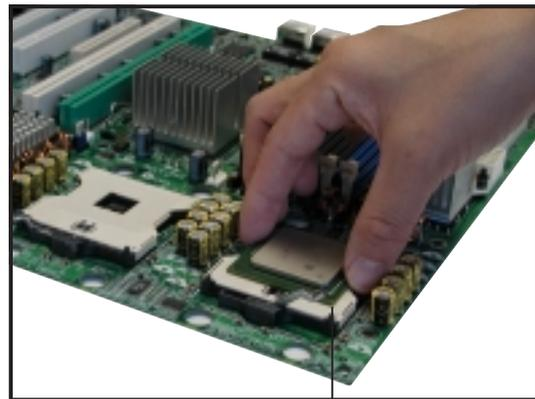

Marked corner
(gold arrow)

5. Carefully push down the socket lever to secure the CPU. The lever clicks on the side tab to indicate that it is locked.
6. Apply the thermal interface material (thermal grease) to the top of the CPU. This thermal grease should come with the CPU package.
7. Repeat steps 1 to 6 if you wish to install a second CPU.

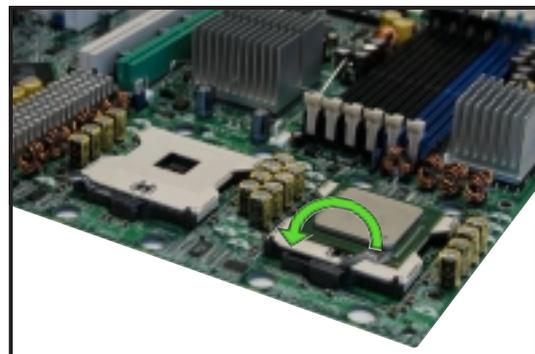

2.3.2 Installing the CPU heatsink and fan

The Intel® Xeon™ processors require an Intel certified heatsink and fan assembly to ensure optimum thermal condition and performance.

When you buy a boxed Intel CPU, the package includes the heatsink, fan, retention brackets, screws, thermal grease, installation manual, and other items that are necessary for CPU installation.



- Make sure that you have applied the thermal grease to the top of the CPU before installing the heatsink and fan.
- Refer to the installation manual that came with the CPU package for details on heatsink/fan assembly and installation.

CPU heatsink (top view)



CPU heatsink (bottom view)

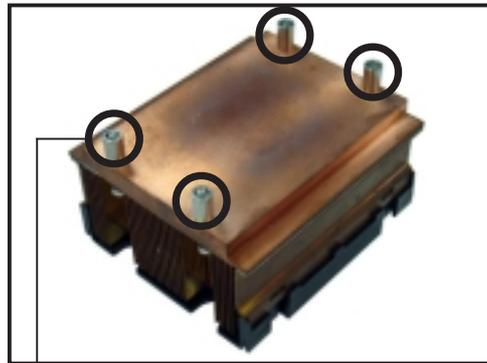

Heatsink screw



Before installing the CPU heatsinks, ensure that the jumpers FM_CPU1 and FM_CPU2 are set correctly depending on the pin definition of your CPU fan cables. Refer to page 2-21 for information on these jumpers.

To install the CPU heatsink and fan:

1. Place the heatsink on top of the installed CPU, making sure that the four screws on the heatsink align with the nuts on the support plate.

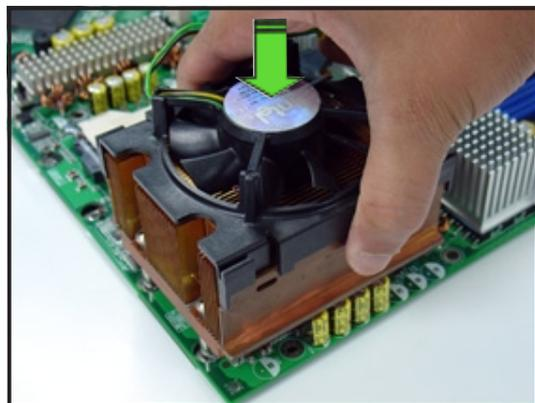

2. Use a Phillips screwdriver to tighten the four heatsink screws in a diagonal sequence.

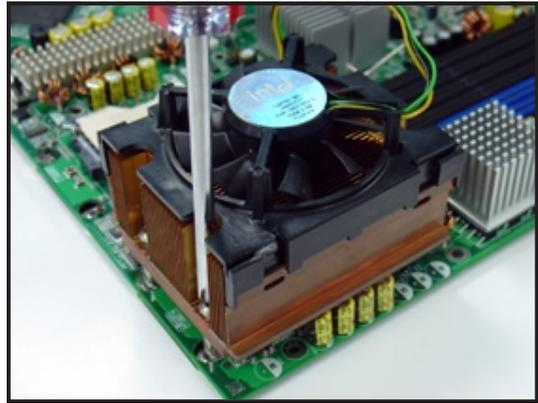

3. Connect the fan cable to the 4-pin connector labeled CPU_FAN1.



Do not forget to connect the CPU fan connector! Hardware monitoring errors may occur if you fail to plug this connector.

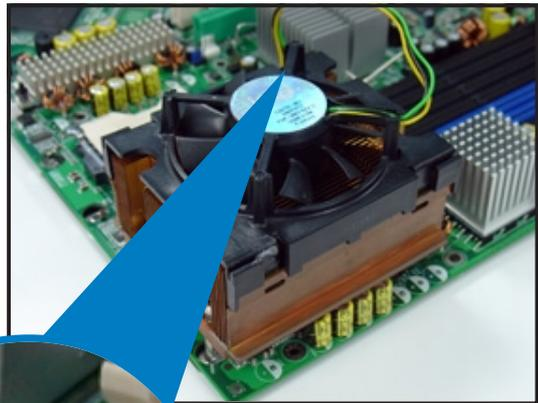

CPU_FAN1
connector

4. Repeat steps 1 to 3 to install the other heatsink if you have installed a second CPU, then connect the fan cable to the 4-pin connector labeled CPU_FAN2.

The heatsinks appear as shown when installed.



CPU_FAN2 connector

2.4 System memory

2.4.1 Overview

The motherboard comes with six Double Data Rate II (DDR2) Dual Inline Memory Modules (DIMM) sockets to support 240-pin DDR modules.

The figure illustrates the location of the DDR DIMM sockets:

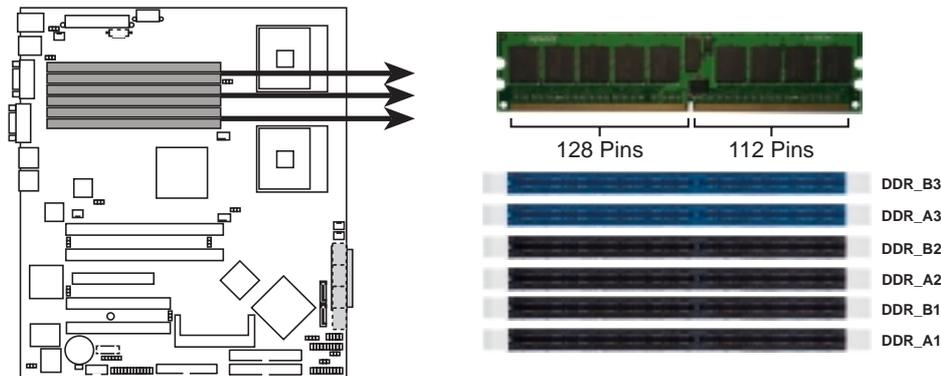

NCLV-D2 Series 240-pin DDR2 DIMM sockets

2.4.2 Memory configurations

You may install 256 MB, 512 MB, 1 GB, 2 GB, and 4 GB registered ECC DDR2-400 DIMMs into the DIMM sockets.



- Always install DIMMs with the same CAS latency. For optimum compatibility, it is recommended that you obtain memory modules from the same vendor. Refer to the DDR2 Qualified Vendors List at the ASUS web site.
- Due to chipset resource allocation, and depending on the number of expansion cards installed, the following conditions may occur:
 - the system may detect less than 8 GB system memory when you installed four 2 GB DDR2 memory modules
 - may show an available memory space of less than 4 GB when you installed four 1 GB DDR2 memory modules
- Three DDR DIMMs installed into any three memory sockets will function in single-channel mode.
- If you are installing only one memory module, install into the blue socket labeled DDR_A3 or DDR_B3. Installing into any other socket would not work.

Mode	DDR_B3 (blue)	DDR_A3 (blue)	DDR_B2 (black)	DDR_A2 (black)	DDR-B1 (black)	DDR_A1 (black)
Single-channel	✓					
		✓				
Dual-channel	✓	✓				
	✓	✓	✓	✓		
	✓	✓	✓	✓	✓	✓

✓ Populated with DIMM

Single and dual rank mixing

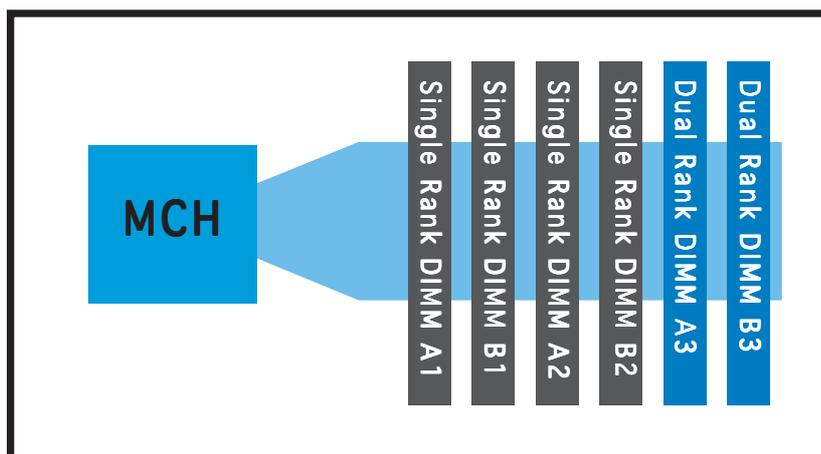
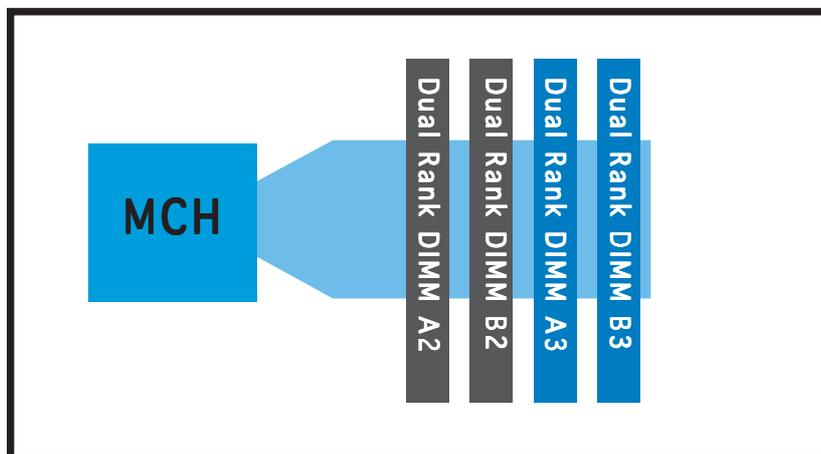

2.4.3 Installing a DIMM



Make sure to unplug the power supply before adding or removing DIMMs or other system components. Failure to do so may cause severe damage to both the motherboard and the components.

To install a DIMM:

1. Unlock a DIMM socket by pressing the retaining clips outward.
2. Align a DIMM on the socket such that the notch on the DIMM matches the break on the socket.
3. Firmly insert the DIMM into the socket until the retaining clips snap back in place and the DIMM is properly seated.

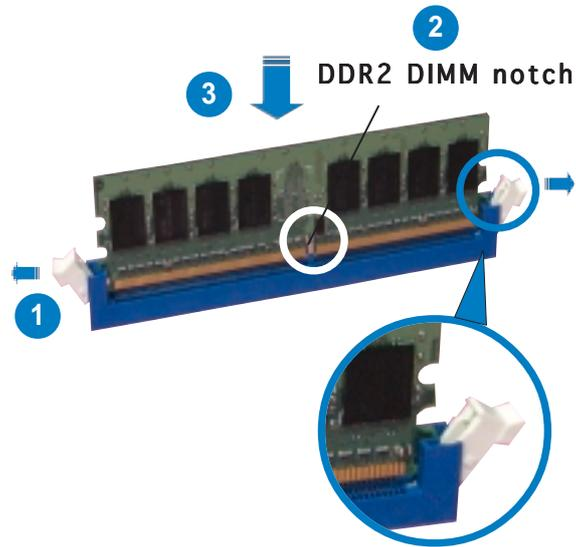

Unlocked retaining clip



- A DDR2 DIMM is keyed with a notch so that it fits in only one direction. Do not force a DIMM into a socket to avoid damaging the DIMM.
- The DDR2 DIMM sockets do not support DDR DIMMs. DO NOT install DDR DIMMs to the DDR2 DIMM sockets.

2.4.4 Removing a DIMM

Follow these steps to remove a DIMM.

1. Simultaneously press the retaining clips outward to unlock the DIMM.



Support the DIMM lightly with your fingers when pressing the retaining clips. The DIMM might get damaged when it flips out with extra force.

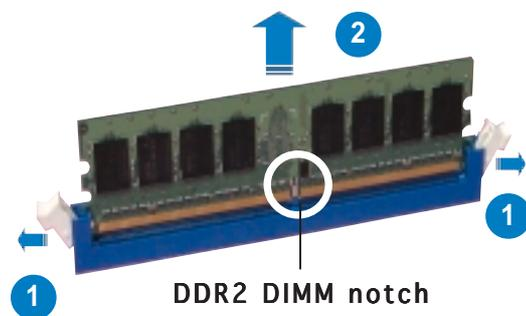

2. Remove the DIMM from the socket.

2.5 Expansion slots

In the future, you may need to install expansion cards. The following sub-sections describe the slots and the expansion cards that they support.



Make sure to unplug the power cord before adding or removing expansion cards. Failure to do so may cause you physical injury and damage motherboard components.

2.5.1 Installing an expansion card

To install an expansion card:

1. Before installing the expansion card, read the documentation that came with it and make the necessary hardware settings for the card.
2. Remove the system unit cover (if your motherboard is already installed in a chassis).
3. Remove the bracket opposite the slot that you intend to use. Keep the screw for later use.
4. Align the card connector with the slot and press firmly until the card is completely seated on the slot.
5. Secure the card to the chassis with the screw you removed earlier.
6. Replace the system cover.

2.5.2 Configuring an expansion card

After installing the expansion card, configure it by adjusting the software settings.

1. Turn on the system and change the necessary BIOS settings, if any. See Chapter 4 for information on BIOS setup.
2. Assign an IRQ to the card. Refer to the tables on the next page.
3. Install the software drivers for the expansion card.



When using PCI cards on shared slots, ensure that the drivers support “Share IRQ” or that the cards do not need IRQ assignments. Otherwise, conflicts will arise between the two PCI groups, making the system unstable and the card inoperable.

2.5.3 Interrupt assignments

Standard interrupt assignments

IRQ	Priority	Standard Function
0	1	System Timer
1	2	Keyboard Controller
2	—	Re-direct to IRQ#9
3	11	Communications Port (COM2)*
4	12	Communications Port (COM1)*
5	13	IRQ holder for PCI steering*
6	14	Floppy Disk Controller
7	15	Printer Port (LPT1)*
8	3	System CMOS/Real Time Clock
9	4	IRQ holder for PCI steering*
10	5	IRQ holder for PCI steering*
11	6	IRQ holder for PCI steering*
12	7	PS/2 Compatible Mouse Port*
13	8	Numeric Data Processor
14	9	Primary IDE Channel
15	10	Secondary IDE Channel

* These IRQs are usually available for ISA or PCI devices.

PCI Bus Number, IDSEL, and IRQ assignments

Description	INTA	INTB	INTC	INTD	REQ#	GNT#
IDE Controller	PIRQC#					
SATA Controller	PIRQC#					
SMBus Controller	PIRQB#					
USB UHCI Controller #1	PIRQA#					
USB UHCI Controller #2	PIRQD#					
USB 2.0 EHCI Controller	PIRQH#					
AIC7901 SCSI controller	PXIRQ2#				X_REQ3#	X_GNT3#
ATI RAGE XL	PIRQB#				REQ2#	GNT2#
PCIX Slot 1	PXIRQ0#	PXIRQ1#	PXIRQ2#	PXIRQ3#	X_IRQ0#	X_IRQ0#
PCIX Slot 2	PXIRQ3#	PXIRQ1#	PXIRQ0#	PXIRQ2#	X_IRQ1#	X_IRQ1#
PCI Express Slot3						
PCIX Slot 4	PIRQE#	PIRF#	PIRQG#	PIRQH#	REQ0#	GNT0#
PCIX Slot 5	PIRQG#	PIRQH#	PIRQE#	PIRF#	REQ1#	GNT1#

2.5.4 PCI/PCI-X slots

The PCI/PCI-X slots support cards such as a LAN card, SCSI card, USB card, and other cards that comply with PCI 2.3 and PCI-X 1.0 specifications. The figure shows a RAID card installed on a PCI-X slot.

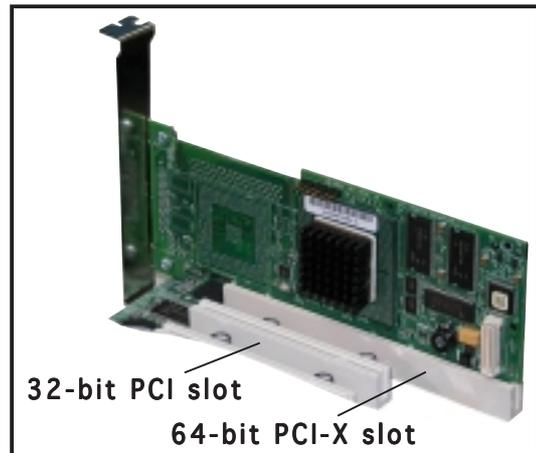

2.5.5 PCI Express x8 slot

The onboard PCI Express x8 slot provides x4 link to the MCH. This slot is designed for various server class high performance add-on cards like SCSI RAID card, fiber-channel card, etc.

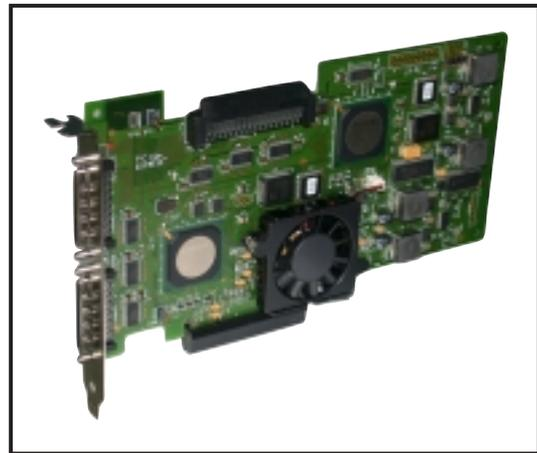

2.5.6 ZCR slot

The 64-bit PCI-X slot (green) on the motherboard supports a Zero-Channel RAID card that allows all types of RAID configurations.

2.6 Jumpers



The grayed out components in the illustrations may not be present in certain models.

1. Clear RTC RAM (CLRTC1)

This jumper allows you to clear the Real Time Clock (RTC) RAM in CMOS. You can clear the CMOS memory of date, time, and system setup parameters by erasing the CMOS RTC RAM data. The onboard button cell battery powers the RAM data in CMOS, which include system setup information such as system passwords.

To erase the RTC RAM:

1. Turn OFF the computer and unplug the power cord.
2. Remove the onboard battery.
3. Move the jumper cap from pins 1-2 (default) to pins 2-3. Keep the cap on pins 2-3 for about 5~10 seconds, then move the cap back to pins 1-2.
4. Re-install the battery.
5. Plug the power cord and turn ON the computer.
6. Hold down the key during the boot process and enter BIOS setup to re-enter data.



Except when clearing the RTC RAM, never remove the cap on CLRTC jumper default position. Removing the cap will cause system boot failure!

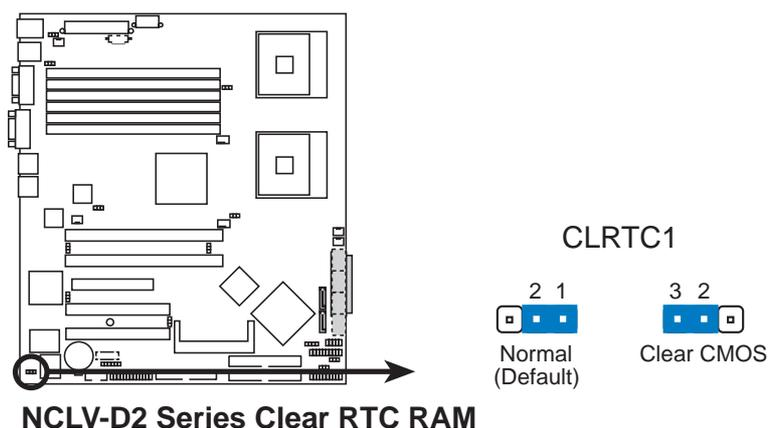

2. CPU fan pin selection (3-pin FM_CPU1, FM_CPU2)

These jumpers allow you to connect either a 3-pin or a 4-pin fan cable plug to the CPU fan connectors (CPU_FAN1, CPU_FAN2). Set these jumpers to pins 1-2 if you are using a 3-pin fan cable plug, or to pins 2-3 if you are using a 4-pin plug.

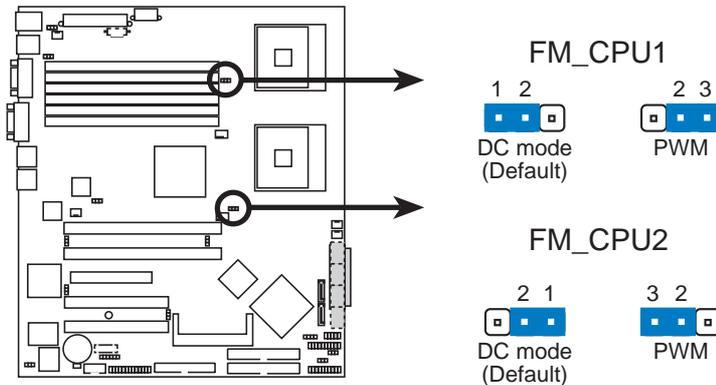

NCLV-D2 Series FM_CPU Setting

3. USB device wake-up (3-pin USBPW12, USBPW34)

Set these jumpers to +5V to wake up the computer from S1 sleep mode (CPU stopped, DRAM refreshed, system running in low power mode) using the connected USB devices. Set to +5VSB to wake up from S4 sleep mode (no power to CPU, DRAM in slow refresh, power supply in reduced power mode).

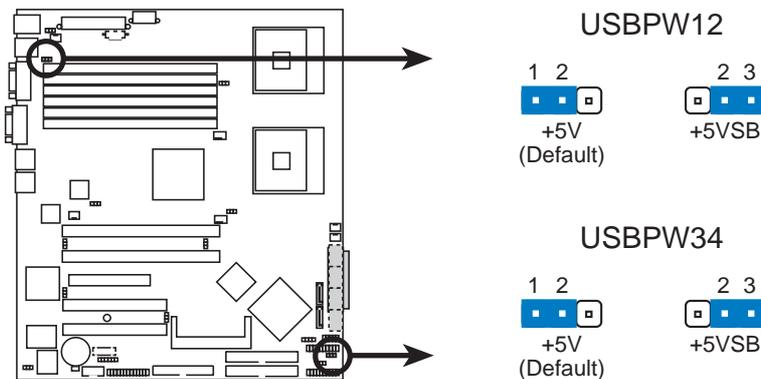

NCLV-D2 Series USB device wake-up



- The USB device wake-up feature requires a power supply that can provide 500mA on the +5VSB lead for each USB port; otherwise, the system would not power up.
- If you are using Windows 2000, you need to install Service Pack 4 to wake up the system from S4 sleep mode.
- The total current consumed must NOT exceed the power supply capability (+5VSB) whether under normal condition or in sleep mode.

4. Keyboard power (3-pin KBPWR1)

This jumper allows you to enable or disable the keyboard wake-up feature. Set this jumper to pins 2-3 (+5VSB) to wake up the computer when you press a key on the keyboard (the default is the Space Bar). This feature requires an ATX power supply that can supply at least 1A on the +5VSB lead, and a corresponding setting in the BIOS.

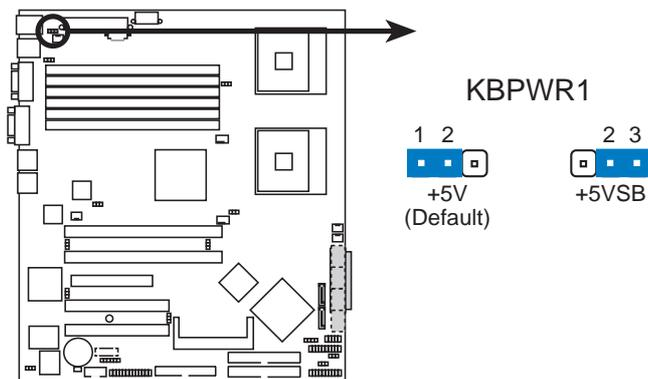

NCLV-D2 Series Keyboard power setting

5. VGA controller setting (3-pin VGA_EN1)

These jumpers allow you to enable or disable the onboard ATI® RAGE-XL PCI VGA controller. Set to pins 1-2 to activate the VGA feature.

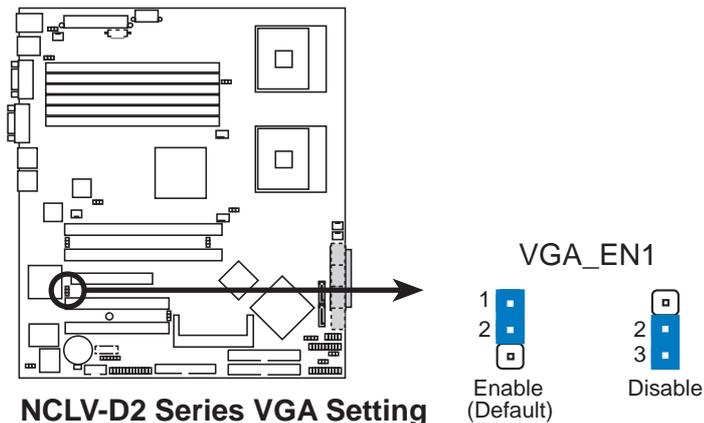

NCLV-D2 Series VGA Setting

6. Gigabit LAN controller setting (3-pin LAN1_EN1)

This jumper allows you to enable or disable the onboard Broadcom® BCM5721 Gigabit LAN1 controller. Set to pins 1-2 to activate the Gigabit LAN feature.

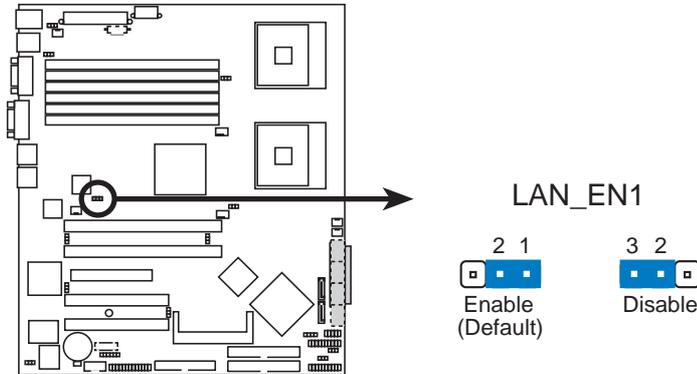

NCLV-D2 Series LAN_EN1 setting

7. Gigabit LAN controller setting (3-pin LAN2_EN1)

These jumpers allow you to enable or disable the onboard Broadcom® BCM5705E Gigabit LAN2 controller. Set to pins 1-2 to activate the Gigabit LAN feature.

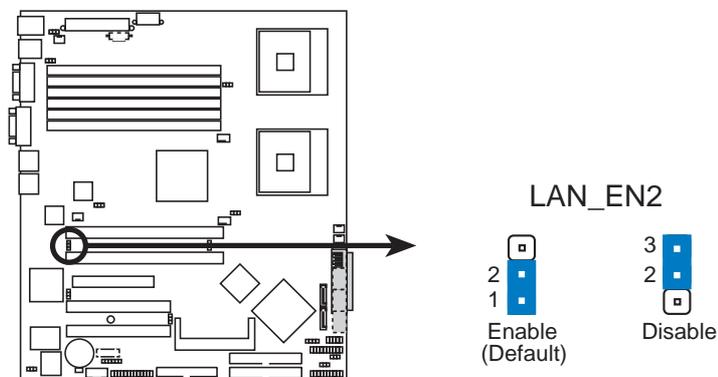

NCLV-D2 Series LAN_EN2 setting

8. SCSI controller setting (3-pin SCSI_EN1)

(NCLV-DS2 model only)

This jumper allows you to enable or disable the onboard Adaptec® AIC-7901X SCSI U320 controller. Set to pins 1-2 to activate the SCSI feature, and support RAID configurations.

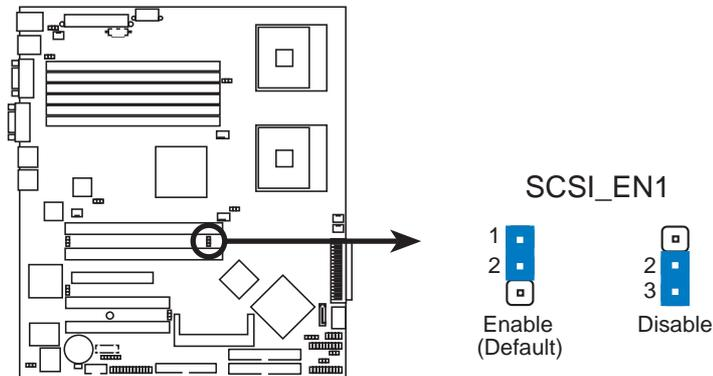

NCLV-D2 Series SCSI setting

9. SATA controller setting (3-pin SATA_EN1)

(NCLV-D2/SATA model only)

This jumper allows you to enable or disable the onboard Adaptec® AIC-8130 SATA II controller. Set to pins 1-2 to activate the SATA connectors.

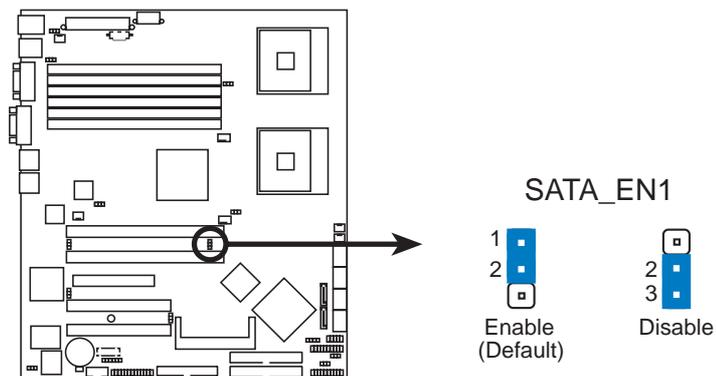

NCLV-D2 Series SATA setting

10. Adaptec 8130 LED setting (3-pin 8130LED1)

(NCLV-D2/SATA model only)

This jumper allows you to enable or disable the LED related to the Adaptec® AIC-8130 SATA-II controller.

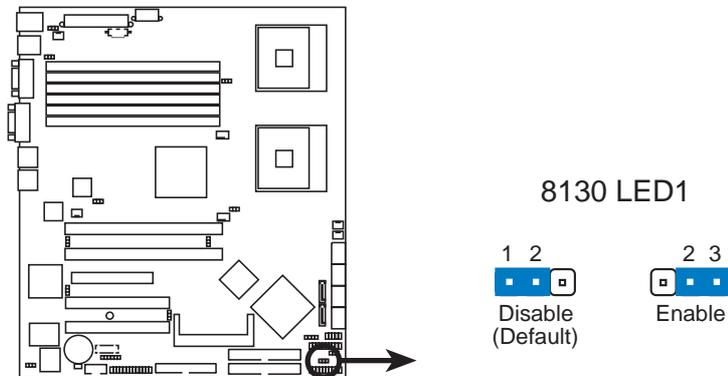

NCLV-D2 Series 8130 LED setting

11. Force BIOS recovery setting (3-pin RECOVERY1)

This jumper allows you to quickly update or recover the BIOS settings when it becomes corrupted.

To update the BIOS:

1. Prepare a floppy disk that contains the latest BIOS for the motherboard (xxxx-xxx.ROM) and the AFUDOS.EXE utility.
2. Set the jumper to pins 2-3.
3. Insert the floppy disk then turn on the system to update the BIOS.
4. Shut down the system.
5. Set the jumper back to pins 1-2.
6. Turn on the system.

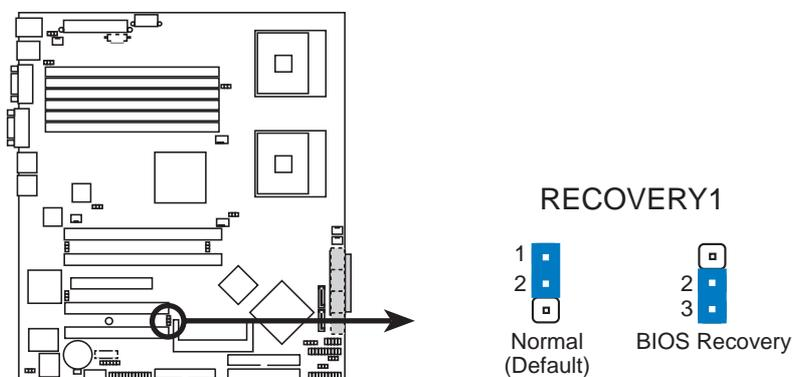

NCLV-D2 Series BIOS recovery setting

2.7 Connectors

2.7.1 Rear panel connectors

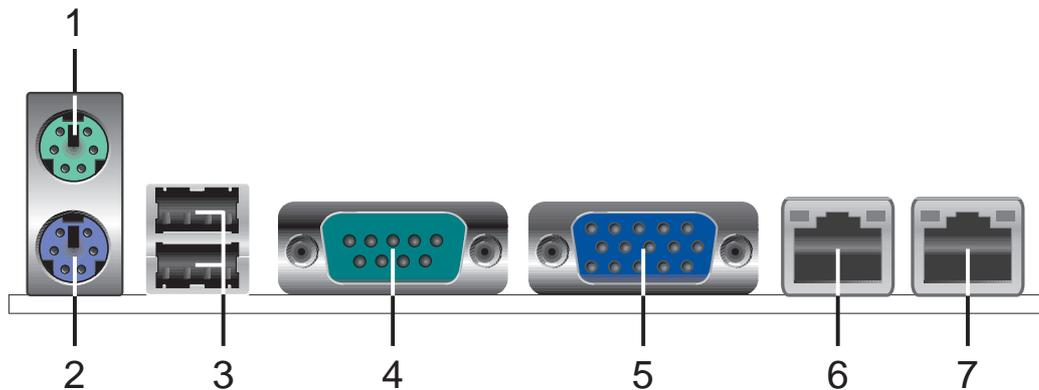

1. **PS/2 mouse port (green).** This port is for a PS/2 mouse.
2. **PS/2 keyboard port (purple).** This port is for a PS/2 keyboard.
3. **USB 2.0 ports 1 and 2.** These two 4-pin Universal Serial Bus (USB) ports are available for connecting USB 2.0 devices.
4. **Serial (COM1) port.** This 9-pin communication port is for pointing devices or other serial devices.
5. **VGA port.** This port is for a VGA monitor or other VGA-compatible devices.
6. **Gigabit LAN1 (RJ-45) port.** This ports allow Gigabit connection to a Local Area Network (LAN) through a network hub. Refer to the table below for the LAN port LED indications.
7. **Gigabit LAN2 (RJ-45) port.** This ports allow Gigabit connection to a Local Area Network (LAN) through a network hub. Refer to the table below for the LAN port LED indications.

LAN port LED indications

ACT/LINK LED		SPEED LED	
Status	Description	Status	Description
OFF	No link	OFF	10 Mbps connection
GREEN	Linked	ORANGE	100 Mbps connection
BLINKING	Data activity	GREEN	1000 Mbps connection

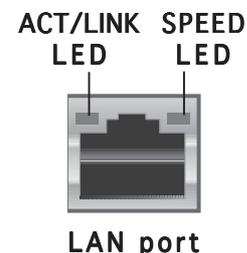

2.7.2 Internal connectors

1. Floppy disk drive connector (34-1 pin FLOPPY)

This connector is for the provided floppy disk drive (FDD) signal cable. Insert one end of the cable to this connector, then connect the other end to the signal connector at the back of the floppy disk drive.



Pin 5 on the connector is removed to prevent incorrect cable connection when using a FDD cable with a covered Pin 5.

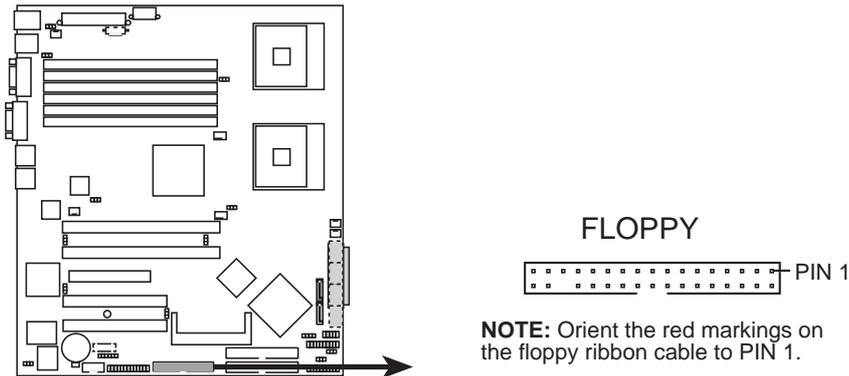

NCLV-D2 Series Floppy disk drive connector

2. IDE connectors (40-1 pin PRI_IDE1, SEC_IDE1)

These connectors are for an Ultra DMA 100/66 signal cable. The Ultra DMA 100/66 signal cable has three connectors: a blue connector for the primary IDE connector on the motherboard, a black connector for an Ultra DMA 100/66 IDE slave device (optical drive/hard disk drive), and a gray connector for an Ultra DMA 100/66 IDE master device (hard disk drive). If you install two hard disk drives, you must configure the second drive as a slave device by setting its jumper accordingly. Refer to the hard disk documentation for the jumper settings.



- Pin 20 on the IDE connector is removed to match the covered hole on the Ultra DMA cable connector. This prevents incorrect insertion when you connect the IDE cable.
- Use the 80-conductor IDE cable for Ultra DMA 100/66 IDE devices.

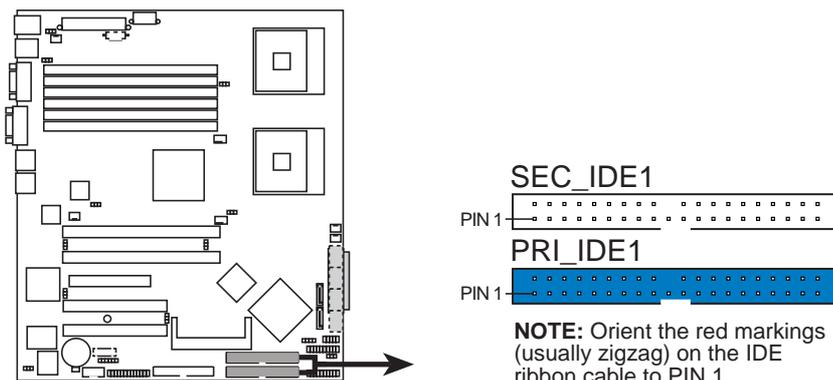

NCLV-D2 Series IDE connectors

3. Serial ATA connectors (7-pin SATA1, SATA2)

These connectors are for the Serial ATA signal cables for Serial ATA hard disk drives.

If you installed Serial ATA hard disk drives, you can create a RAID 0 or RAID 1 set LSI Logic Embedded SATA RAID in the Intel® 6300ESB Southbridge chip.



These connectors are set to **Standard IDE** mode by default. In **Standard IDE** mode, you can connect Serial ATA boot/data hard disk drives to these connectors. If you intend to create a Serial ATA RAID set using these connectors, set the **Configure S-ATA as RAID** item in the BIOS to [Yes]. See section “4.3.4 IDE Configuration” for details.

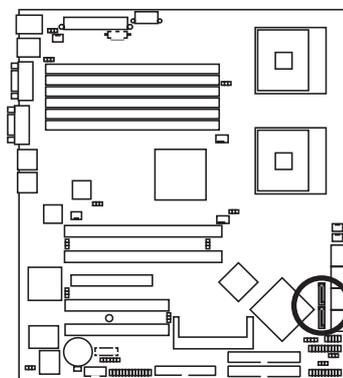

NCLV-D2/SATA SATA connectors

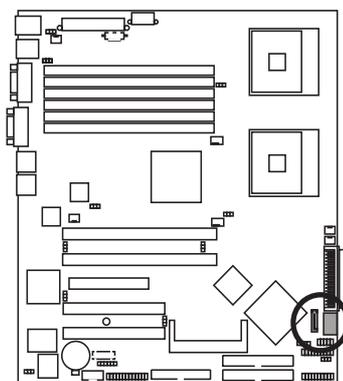
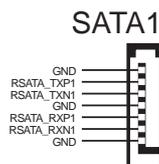
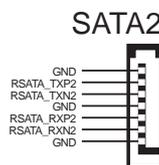

NCLV-DS2 SATA connectors

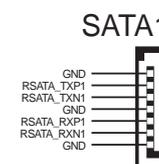
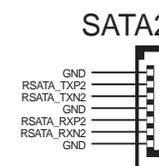

Important notes on Serial ATA

- You must install Windows® 2000 Service Pack 4 or the Windows® XP Service Pack 1 before using Serial ATA hard disk drives. The Serial ATA RAID feature (RAID 0 or RAID 1) is available only if you are using Windows® 2000/XP.
- Use only two Serial ATA RAID connectors for each RAID 0 or RAID 1 set.
- When using the connectors in **Standard IDE** mode, connect the primary (boot) hard disk drive to the SATA1 connector. Refer to the table on the next page for recommended SATA hard disk drive connections.

Serial ATA hard disk drive connection

Connector	Setting	Use
SATA1	Master	Boot disk
SATA2	Slave	Data disk

4. Serial ATA RAID connectors (7-pin SATA_RAID1, SATA_RAID2, SATA_RAID3, SATA_RAID4) (NCLV-D2/SATA model only)

These connectors are for the Serial ATA signal cables. These connectors support up to four SATA hard disk drives that you can configure as an array through the onboard Adaptec® AIC-8130 PCI-X SATAII controller.

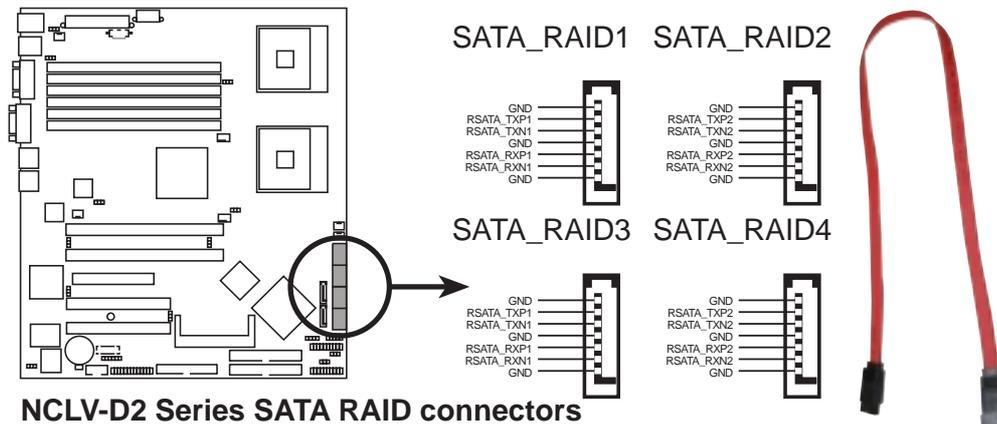

NCLV-D2 Series SATA RAID connectors

5. Hard disk activity LED connector (4-pin HDLED1)

This connector supplies power to the hard disk activity LED. The read or write activities of any device connected to the SCSI connectors or the SATA connectors cause this LED to light up.

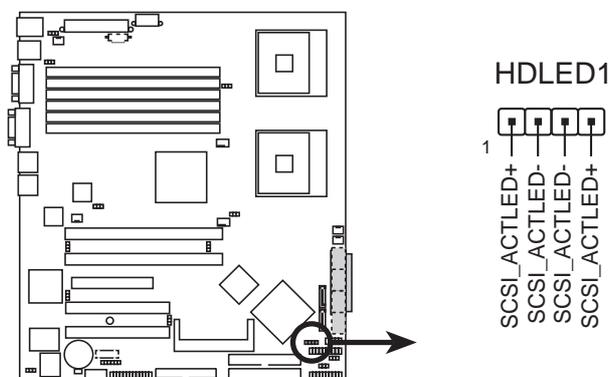

NCLV-D2 Series SCSI/SATA card activity LED connector

6. Ultra320 SCSI connector (68-pin SCSI1)

(NCLV-D2/SATA model only)

This motherboard comes with the Adaptec® AIC-7901X PCI-X SCSI controller that supports one 68-Pin Ultra320 SCSI connector. The SCSI channel can support a maximum of 15 SCSI devices as specified by Ultra320 standards.

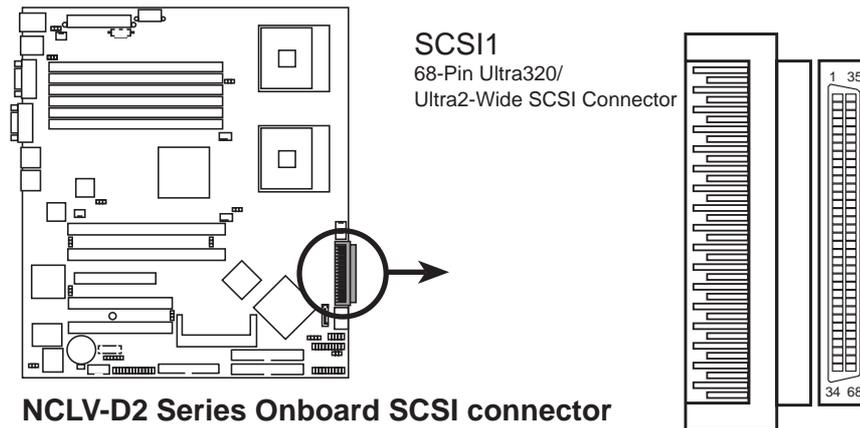

SCSI Connection Notes

This motherboard has a 68-Pin Ultra320 SCSI connector.

The onboard SCSI chipset incorporates an advanced multimode I/O cell that supports both single-ended (SE), Ultra2, Ultra160, and Ultra320 devices. With Ultra320 devices, the SCSI bus platform performs at full Ultra320 speeds (up to 320 MB/s) and extended cabling 12m (or 25m in a point-to-point configuration). When an SE device is attached, the bus defaults to an SE speed and 1.5m cable length.



Connect SCSI devices as specified. A SCSI channel should have only one type of SCSI standard (e.g. Ultra320, Ultra160, Ultra2, Ultra-Wide). Mixing SCSI devices on a single channel decreases performance of the slower device.

7. USB connector (10-1 pin USB34)

This connector is for USB 2.0 ports. Connect the USB module cable to this connector, then install the module to a slot opening at the back of the system chassis. This USB connector complies with USB 2.0 specification that supports up to 480 Mbps connection speed.

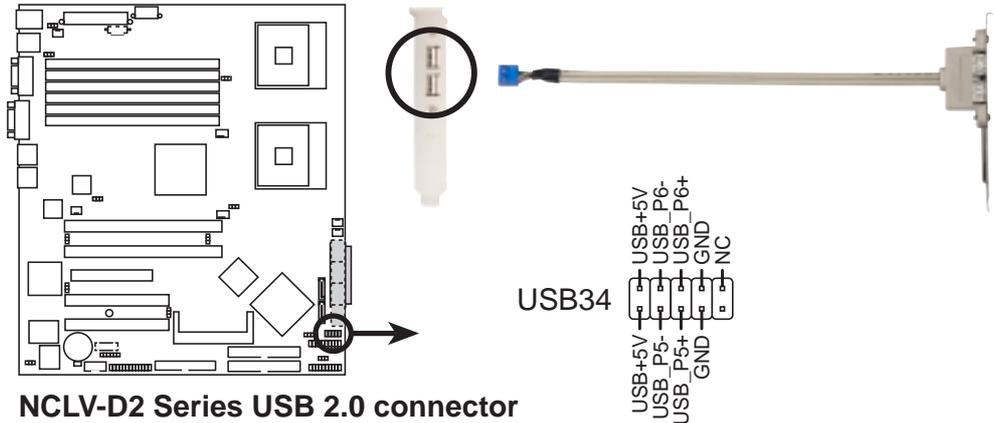

The USB port module is purchased separately.

8. Serial port connector (10-1 pin COM2)

This connector is for a serial (COM) port. Connect the serial port module cable to this connector, then install the module to a slot opening at the back of the system chassis.

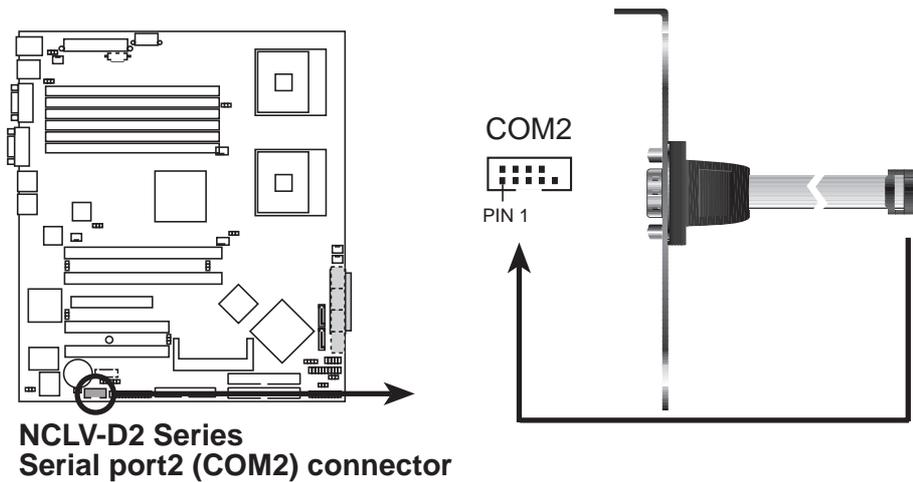

The serial port module is purchased separately.

9. CPU, rear, and front fan connectors (3-pin CPU_FAN1/2, REAR_FAN1/2, FRNT_FAN1/2)

The fan connectors support cooling fans of 350 mA ~ 740 mA (8.88 W max.) or a total of 2.1 A ~ 4.44 A (53.28 W max.) at +12V. Connect the fan cables to the fan connectors on the motherboard, making sure that the black wire of each cable matches the ground pin of the connector.



Do not forget to connect the fan cables to the fan connectors. Insufficient air flow inside the system may damage the motherboard components. These are not jumpers! Do not place jumper caps on the fan connectors!

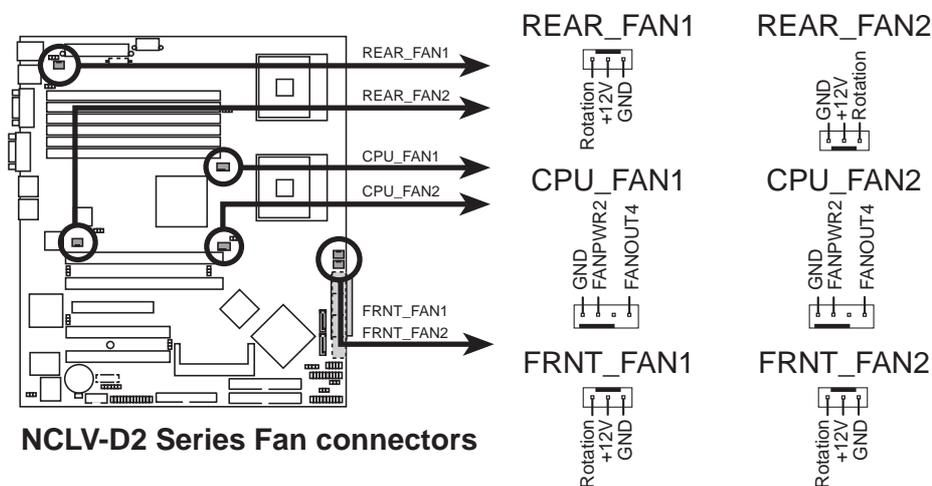

10. BMC connector (16-pin BMCCONN1)

This connector is for the ASUS server management card, if available.

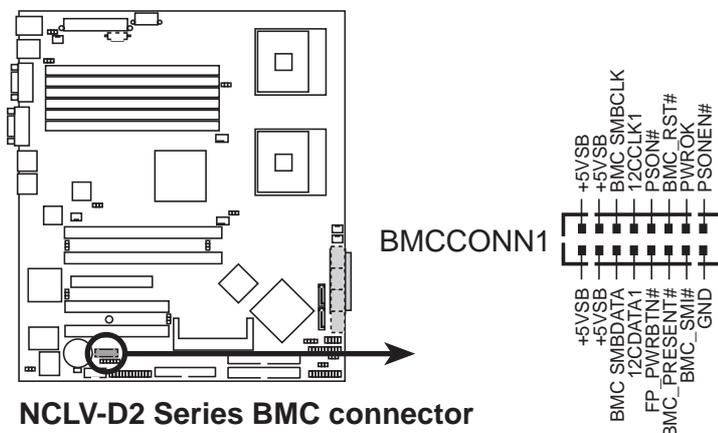

11. Backplane SMBus connector (6-1 pin BPSMB1)

This connector allows you to connect SMBus (System Management Bus) devices. Devices communicate with an SMBus host and/or other SMBus devices using the SMBus interface.

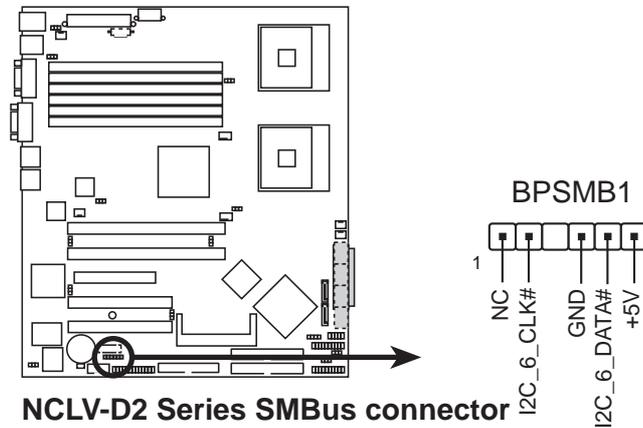

12. Power supply SMBus connector (5-pin PSUSMB1)

This connector is for the power supply SMB cable, if your power supply supports the SMBus function.

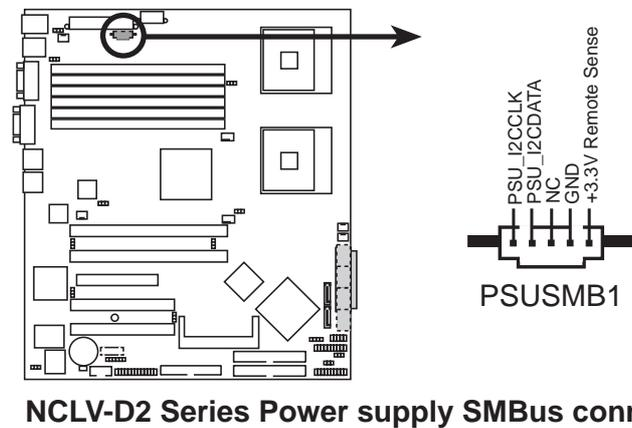

13. ATX power connectors (24-pin ATXPWR1, 8-pin ATX12V1)

These connectors are for SSI power supply plugs. The power supply plugs are designed to fit these connectors in only one orientation. Find the proper orientation and push down firmly until the connectors completely fit.



- Use of an SSI 12 V Specification 2.0-compliant power supply unit (PSU) that provides a minimum power of 600 W is recommended for a fully-configured system.
- Do not forget to connect the 8-pin ATX +12 V power plug; otherwise, the system will not boot up.
- Use of a PSU with a higher power output is recommended when configuring a system with more power consuming devices. The system may become unstable or may not boot up if the power is inadequate.
- You must install a PSU with a higher power rating if you intend to install additional devices.

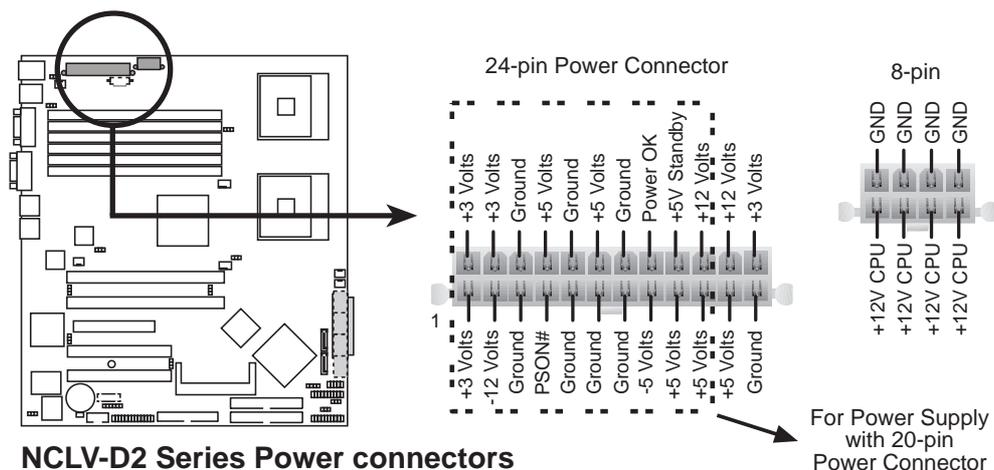

14. System panel connector (20-pin PANEL1)

This connector supports several chassis-mounted functions.

- **System power LED (Green 3-pin PLED)**
This 3-pin connector is for the system power LED. Connect the chassis power LED cable to this connector. The system power LED lights up when you turn on the system power, and blinks when the system is in sleep mode.
- **Hard disk drive activity LED (Red 2-pin IDE_LED)**
This 2-pin connector is for the HDD Activity LED. Connect the HDD Activity LED cable to this connector. The IDE LED lights up or flashes when data is read from or written to the HDD.
- **System warning speaker (Orange 4-pin SPEAKER)**
This 4-pin connector is for the chassis-mounted system warning speaker. The speaker allows you to hear system beeps and warnings.
- **ATX power button/soft-off button (Light Green 2-pin PWRSW)**
This connector is for the system power button. Pressing the power button turns the system on or puts the system in sleep or soft-off mode depending on the BIOS settings. Pressing the power switch for more than four seconds while the system is ON turns the system OFF.
- **Reset button (Blue 2-pin RESET)**
This 2-pin connector is for the chassis-mounted reset button for system reboot without turning off the system power.

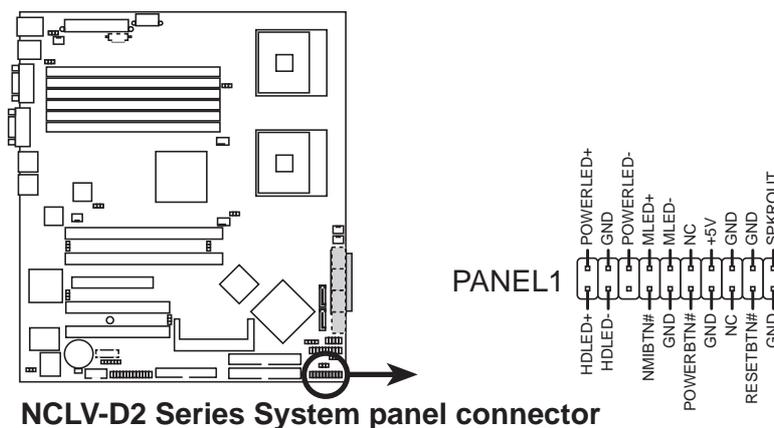

NCLV-D2 Series System panel connector



The system panel connector is color-coded for easy connection.

15. Auxiliary panel connector (20-pin AUX_PANEL1)

This connector is for additional front panel features including front panel SMB, locator LED and switch, chassis intrusion, and LAN LEDs.

- **Front panel SMB (6-1 pin FPSMB)**
These leads connect the front panel SMBus cable.
- **LAN activity LED (2-pin LAN1_LED, LAN2_LED)**
These leads are for Gigabit LAN activity LEDs on the front panel.
- **Chassis intrusion (4-1 pin CHASSIS)**
These leads are for the intrusion detection feature for chassis with intrusion sensor or microswitch. When you remove any chassis component, the sensor triggers and sends a high-level signal to these leads to record a chassis intrusion event.
- **Locator LED (6-pin LOCATOR)**
These leads are for the locator switch and LED on the front panel.

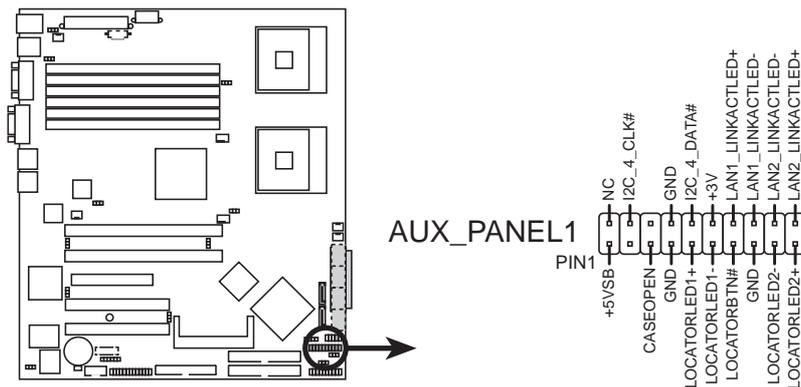

NCLV-D2 Series Auxiliary panel connector

This chapter describes the power up sequence, and ways of shutting down the system.

Powering up

Chapter summary

3

3.1	Starting up for the first time	3-1
3.2	Powering off the computer	3-2

3.1 Starting up for the first time

1. After making all the connections, replace the system case cover.
2. Be sure that all switches are off.
3. Connect the power cord to the power connector at the back of the system chassis.
4. Connect the power cord to a power outlet that is equipped with a surge protector.
5. Turn on the devices in the following order:
 - a. Monitor
 - b. External SCSI devices (starting with the last device on the chain)
 - c. System power
6. After applying power, the system power LED on the system front panel case lights up. For systems with ATX power supplies, the system LED lights up when you press the ATX power button. If your monitor complies with “green” standards or if it has a “power standby” feature, the monitor LED may light up or switch between orange and green after the system LED turns on.

The system then runs the power-on self tests or POST. While the tests are running, the BIOS beeps (see BIOS beep codes table below) or additional messages appear on the screen. If you do not see anything within 30 seconds from the time you turned on the power, the system may have failed a power-on test. Check the jumper settings and connections or call your retailer for assistance.

AMI BIOS beep codes

Beep Description	Error
One beep	Keyboard controller error Refresh Time error No master drive detected
Two continuous beeps followed by two short beeps	Floppy controller failure
Two continuous beeps followed by four short beeps	Hardware component failure

7. At power on, hold down the <Delete> key to enter the BIOS Setup. Follow the instructions in Chapter 4.

3.2 Powering off the computer

3.2.1 Using the OS shut down function

If you are using Windows® 2000:

1. Click the **Start** button then click **Shut Down...**
2. Make sure that the **Shut Down** option button is selected, then click the **OK** button to shut down the computer.
3. The power supply should turn off after Windows® shuts down.

If you are using Windows® XP:

1. Click the **Start** button then select **Turn Off Computer.**
2. Click the **Turn Off** button to shut down the computer.
3. The power supply should turn off after Windows® shuts down.

3.2.2 Using the dual function power switch

While the system is ON, pressing the power switch for less than four seconds puts the system to sleep mode or to soft-off mode, depending on the BIOS setting. Pressing the power switch for more than four seconds lets the system enter the soft-off mode regardless of the BIOS setting. Refer to section “4.4.4 Power Configuration” in Chapter 4 for details.

This chapter tells how to change the system settings through the BIOS Setup menus. Detailed descriptions of the BIOS parameters are also provided.

BIOS setup

4.1	Managing and updating your BIOS	4-1
4.2	BIOS setup program	4-10
4.3	Main menu	4-13
4.4	Advanced menu	4-18
4.5	Server menu	4-30
4.6	Security	4-32
4.7	Boot menu	4-35

4.1 Managing and updating your BIOS

The following utilities allow you to manage and update the motherboard Basic Input/Output System (BIOS) setup.

1. **ASUS AFUDOS** (Updates the BIOS in DOS mode using a bootable floppy disk.)
2. **ASUS CrashFree BIOS 2** (Updates the BIOS using a bootable floppy disk or the motherboard support CD when the BIOS file fails or gets corrupted.)
3. **ASUS Update** (Updates the BIOS in Windows® environment.)

Refer to the corresponding sections for details on these utilities.



Save a copy of the original motherboard BIOS file to a bootable floppy disk in case you need to restore the BIOS in the future. Copy the original motherboard BIOS using the ASUS Update or AFUDOS utilities.

4.1.1 Creating a bootable floppy disk

1. Do either one of the following to create a bootable floppy disk.

DOS environment

- a. Insert a 1.44MB floppy disk into the drive.
- b. At the DOS prompt, type **format A:/S** then press <Enter>.

Windows® XP environment

- a. Insert a 1.44 MB floppy disk to the floppy disk drive.
 - b. Click **Start** from the Windows® desktop, then select **My Computer**.
 - c. Select the 3 1/2 Floppy Drive icon.
 - d. Click **File** from the menu, then select **Format**. A **Format 3 1/2 Floppy Disk** window appears.
 - e. **Windows® XP users:** Select **Create an MS-DOS startup disk** from the format options field, then click **Start**.
2. Copy the original or the latest motherboard BIOS file to the bootable floppy disk.

4.1.2 AFUDOS utility

The AFUDOS utility allows you to update the BIOS file in DOS environment using a bootable floppy disk with the updated BIOS file. This utility also allows you to copy the current BIOS file that you can use as backup when the BIOS fails or gets corrupted during the updating process.

Copying the current BIOS

To copy the current BIOS file using the AFUDOS utility:



-
- Make sure that the floppy disk is not write-protected and has at least 1024 KB free space to save the file.
 - The succeeding BIOS screens are for reference only. The actual BIOS screen displays may not be same as shown.
-

1. Copy the AFUDOS utility (afudos.exe) from the motherboard support CD to the bootable floppy disk you created earlier.
2. Boot the system in DOS mode, then at the prompt type:

```
afudos /o[filename]
```

where the [filename] is any user-assigned filename not more than eight alphanumeric characters for the main filename and three alphanumeric characters for the extension name.

```
A:\>afudos /oOLDBIOS1.rom
```

Main filename Extension name

3. Press <Enter>. The utility copies the current BIOS file to the floppy disk.

```
A:\>afudos /oOLDBIOS1.rom
AMI Firmware Update Utility - Version 1.19(ASUS V2.07(03.11.24BB))
Copyright (C) 2002 American Megatrends, Inc. All rights reserved.
  Reading flash ..... done
  Write to file..... ok
A:\>
```

The utility returns to the DOS prompt after copying the current BIOS file.

Updating the BIOS file

To update the BIOS file using the AFUDOS utility:

1. Visit the ASUS website (www.asus.com) and download the latest BIOS file for the motherboard. Save the BIOS file to a bootable floppy disk.



Write the BIOS filename on a piece of paper. You need to type the exact BIOS filename at the DOS prompt.

2. Copy the AFUDOS utility (afudos.exe) from the motherboard support CD to the bootable floppy disk you created earlier.
3. Boot the system in DOS mode, then at the prompt type:

```
afudos /i[filename]
```

where [filename] is the latest or the original BIOS file on the bootable floppy disk.

```
A:\>afudos /iNCLVDS2.rom
```



Use the appropriate BIOS file depending on your motherboard model (e.g. NCLVD2SATA.ROM or NCLVDS2.ROM)

4. The utility verifies the file and starts updating the BIOS.

```
A:\>afudos /iNCLVDS2.ROM
AMI Firmware Update Utility - Version 1.19(ASUS V2.07(03.11.24BB))
Copyright (C) 2002 American Megatrends, Inc. All rights reserved.

WARNING!! Do not turn off power during flash BIOS
Reading file ..... done
Reading flash ..... done

Advance Check .....
Erasing flash ..... done
Writing flash ..... 0x0008CC00 (9%)
```



Do not shut down or reset the system while updating the BIOS to prevent system boot failure!

5. The utility returns to the DOS prompt after the BIOS update process is completed. Reboot the system from the hard disk drive.

```
A:\>afudos /iNCLVDS2.ROM
AMI Firmware Update Utility - Version 1.19(ASUS V2.07(03.11.24BB))
Copyright (C) 2002 American Megatrends, Inc. All rights reserved.

WARNING!! Do not turn off power during flash BIOS
Reading file ..... done
Reading flash ..... done

Advance Check .....
Erasing flash ..... done
Writing flash ..... done
Verifying flash .... done

Please restart your computer

A:\>
```

4.1.3 ASUS CrashFree BIOS 2 utility

The ASUS CrashFree BIOS 2 is an auto recovery tool that allows you to restore the BIOS file when it fails or gets corrupted during the updating process. You can update a corrupted BIOS file using the motherboard support CD or the floppy disk that contains the updated BIOS file.



- Prepare the motherboard support CD or the floppy disk containing the updated motherboard BIOS before using this utility.
- Make sure that you rename the original or updated BIOS file in the floppy disk according to the exact name of your motherboard, e.g. **NCLVDS2.ROM**.

Recovering the BIOS from a floppy disk

To recover the BIOS from a floppy disk:

1. Turn on the system.
2. Insert the floppy disk with the original or updated BIOS file to the floppy disk drive.
3. The utility displays the following message and automatically checks the floppy disk for the original or updated BIOS file.

```
Bad BIOS checksum. Starting BIOS recovery...
Checking for floppy...
```

When found, the utility reads the BIOS file and starts flashing the corrupted BIOS file.

```
Bad BIOS checksum. Starting BIOS recovery...
Checking for floppy...
Floppy found!
Reading file "NCLVDS2.ROM". Completed.
Start flashing...
```



DO NOT shut down or reset the system while updating the BIOS! Doing so can cause system boot failure!

4. Restart the system after the utility completes the updating process.

Recovering the BIOS from the support CD

To recover the BIOS from the support CD:

1. Remove any floppy disk from the floppy disk drive, then turn on the system.
2. Insert the support CD to the optical drive.
3. The utility displays the following message and automatically checks the floppy disk for the original or updated BIOS file.

```
Bad BIOS checksum. Starting BIOS recovery...
Checking for floppy...
```

When no floppy disk is found, the utility automatically checks the optical drive for the original or updated BIOS file. The utility then updates the corrupted BIOS file.

```
Bad BIOS checksum. Starting BIOS recovery...
Checking for floppy...
Floppy not found!
Checking for CD-ROM...
CD-ROM found!
Reading file "NCLVDS2.ROM". Completed.
Start flashing...
```



DO NOT shut down or reset the system while updating the BIOS! Doing so can cause system boot failure!

4. Restart the system after the utility completes the updating process.



The recovered BIOS may not be the latest BIOS version for this motherboard. Visit the ASUS website (www.asus.com) to download the latest BIOS file.

4.1.4 ASUS Update utility

The ASUS Update is a utility that allows you to manage, save, and update the motherboard BIOS in Windows® environment. The ASUS Update utility allows you to:

- Save the current BIOS file
- Download the latest BIOS file from the Internet
- Update the BIOS from an updated BIOS file
- Update the BIOS directly from the Internet, and
- View the BIOS version information.

This utility is available in the support CD that comes with the motherboard package.



ASUS Update requires an Internet connection either through a network or an Internet Service Provider (ISP).

Installing ASUS Update

To install ASUS Update:

1. Place the support CD in the optical drive. The **Drivers** menu appears.
2. Click the **Utilities** tab, then click **Install ASUS Update VX.XX.XX**.
3. The ASUS Update utility is copied to your system.



Quit all Microsoft® Windows® applications before you update the BIOS using this utility.

Updating the BIOS through the Internet

To update the BIOS through the Internet:

1. Launch the ASUS Update utility from the Windows® desktop by clicking **Start > Programs > ASUS > ASUSUpdate > ASUSUpdate**. The ASUS Update main window appears.

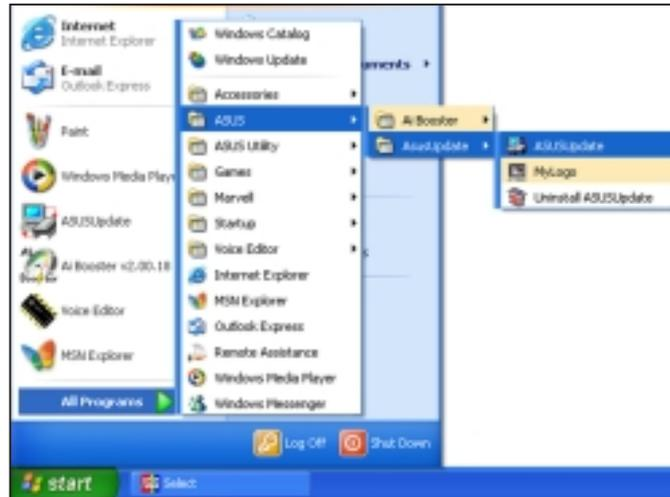

2. Select **Update BIOS from the Internet** option from the drop-down menu, then click **Next**.
3. Select the ASUS FTP site nearest you to avoid network traffic, or click **Auto Select**. Click **Next**.



4. From the FTP site, select the BIOS version that you wish to download. Click Next.
5. Follow the screen instructions to complete the update process.



The ASUS Update utility is capable of updating itself through the Internet. Always update the utility to avail all its features.



Updating the BIOS through a BIOS file

To update the BIOS through a BIOS file:

1. Launch the ASUS Update utility from the Windows® desktop by clicking **Start > Programs > ASUS > ASUSUpdate > ASUSUpdate**. The ASUS Update main window appears.
2. Select **Update BIOS from a file** option from the drop-down menu, then click **Next**.



3. Locate the BIOS file from the **Open** window, then click **Save**.
4. Follow the screen instructions to complete the update process.

4.2 BIOS setup program

This motherboard supports a programmable firmware chip that you can update using the provided utility described in section “4.1 Managing and updating your BIOS.”

Use the BIOS Setup program when you are installing a motherboard, reconfiguring your system, or prompted to “Run Setup”. This section explains how to configure your system using this utility.

Even if you are not prompted to use the Setup program, you can change the configuration of your computer in the future. For example, you can enable the security password feature or change the power management settings. This requires you to reconfigure your system using the BIOS Setup program so that the computer can recognize these changes and record them in the CMOS RAM of the firmware hub.

The firmware hub on the motherboard stores the Setup utility. When you start up the computer, the system provides you with the opportunity to run this program. Press during the Power-On-Self-Test (POST) to enter the Setup utility; otherwise, POST continues with its test routines.

If you wish to enter Setup after POST, restart the system by pressing <Ctrl+Alt+Delete>, or by pressing the reset button on the system chassis. You can also restart by turning the system off and then back on. Do this last option only if the first two failed.

The Setup program is designed to make it as easy to use as possible. Being a menu-driven program, it lets you scroll through the various sub-menus and make your selections from the available options using the navigation keys.



-
- The default BIOS settings for this motherboard apply for most conditions to ensure optimum performance. If the system becomes unstable after changing any BIOS settings, load the default settings to ensure system compatibility and stability. Select the **Load Setup Defaults** item under the Exit Menu. See section “4.8 Exit Menu.”
 - The BIOS setup screens shown in this section are for reference purposes only, and may not exactly match what you see on your screen.
 - Visit the ASUS website (www.asus.com) to download the latest BIOS file for this motherboard.
-

4.2.1 BIOS menu screen

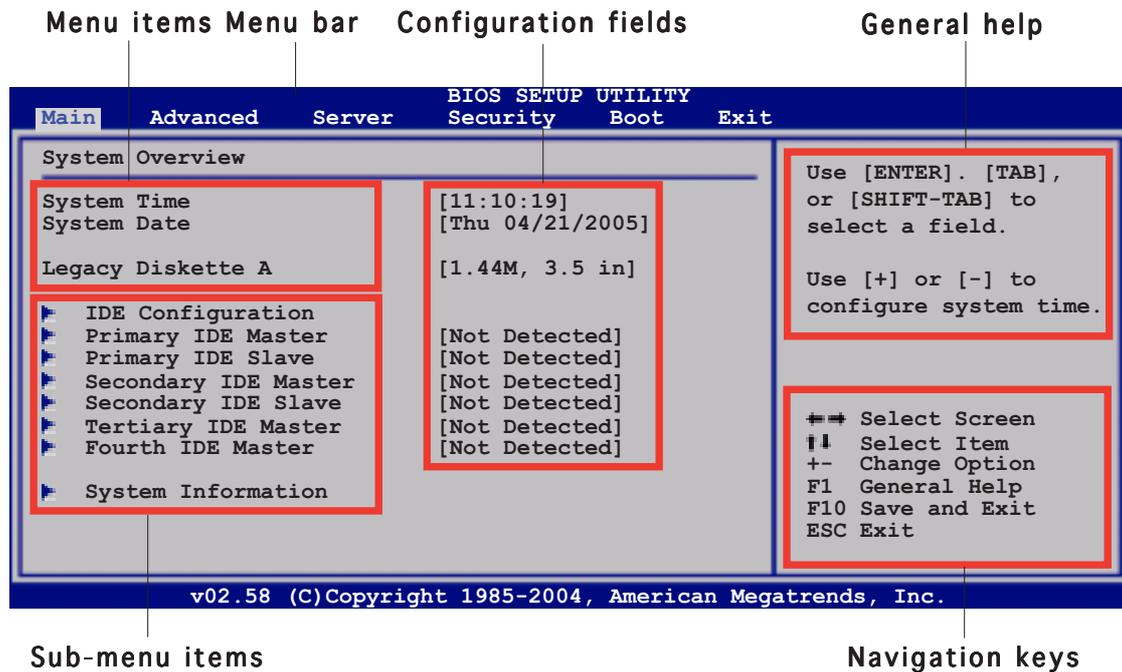

4.2.2 Menu bar

The menu bar on top of the screen has the following main items:

- Main** For changing the basic system configuration
- Advanced** For changing the advanced system settings
- Server** For changing the server settings
- Security** For changing the security settings
- Boot** For changing the system boot configuration
- Exit** For selecting the exit options and loading default settings

To select an item on the menu bar, press the right or left arrow key on the keyboard until the desired item is highlighted.

4.2.3 Navigation keys

At the bottom right corner of a menu screen are the navigation keys for that particular menu. Use the navigation keys to select items in the menu and change the settings.



Some of the navigation keys differ from one screen to another.

4.2.4 Menu items

The highlighted item on the menu bar displays the specific items for that menu. For example, selecting **Main** shows the Main menu items.

The other items (Advanced, Server, Security, Boot, and Exit) on the menu bar have their respective menu items.

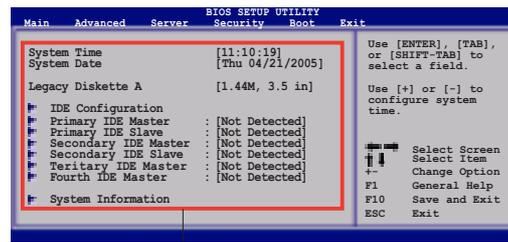

Main menu items

4.2.5 Sub-menu items

A solid triangle before each item on any menu screen means that the item has a sub-menu. To display the sub-menu, select the item and press <Enter>.

4.2.6 Configuration fields

These fields show the values for the menu items. If an item is user-configurable, you can change the value of the field opposite the item. You cannot select an item that is not user-configurable.

A configurable field is enclosed in brackets, and is highlighted when selected. To change the value of a field, select it then press <Enter> to display a list of options. Refer to “4.2.7 Pop-up window.”

4.2.7 Pop-up window

Select a menu item then press <Enter> to display a pop-up window with the configuration options for that item.

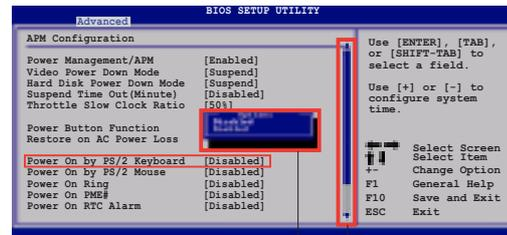

Pop-up window

Scroll bar

4.2.8 Scroll bar

A scroll bar appears on the right side of a menu screen when there are items that do not fit on the screen. Press the Up/Down arrow keys or <Page Up> / <Page Down> keys to display the other items on the screen.

4.2.9 General help

At the top right corner of the menu screen is a brief description of the selected item.

4.3 Main menu

When you enter the BIOS Setup program, the **Main** menu screen appears, giving you an overview of the basic system information.



Refer to section “4.2.1 BIOS menu screen” for information on the menu screen items and how to navigate through them.

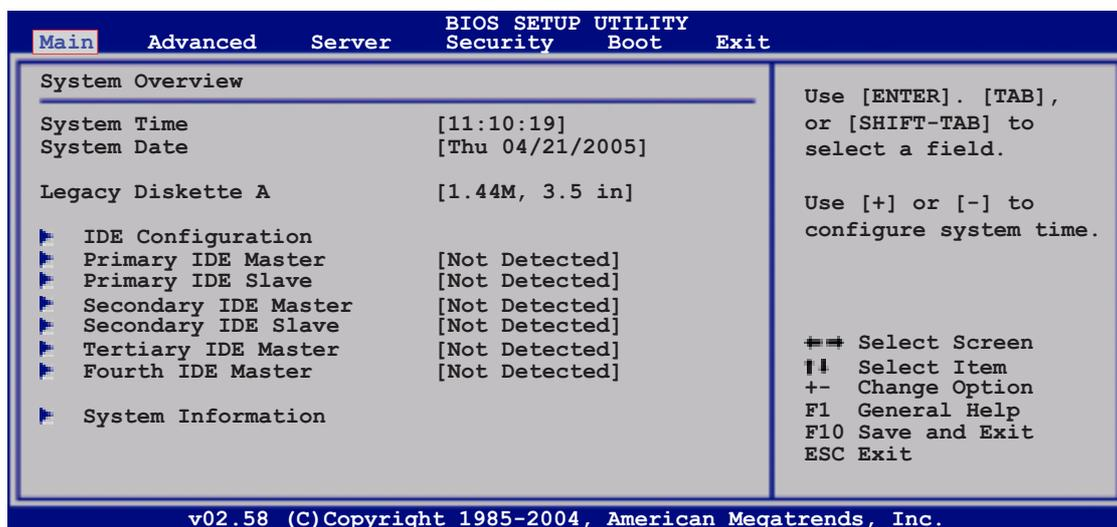

4.3.1 System Time [xx:xx:xx]

Allows you to set the system time.

4.3.2 System Date [Day xx/xx/xxxx]

Allows you to set the system date.

4.3.3 Legacy Diskette A [1.44M, 3.5 in.]

Sets the type of floppy drive installed. Configuration options: [Disabled]
[360K, 5.25 in.] [1.2M , 5.25 in.] [720K , 3.5 in.] [1.44M, 3.5 in.]
[2.88M, 3.5 in.]

4.3.4 IDE Configuration

The items in this menu allow you to set or change the configurations for the IDE devices installed in the system. Select an item then press <Enter> if you wish to configure the item.

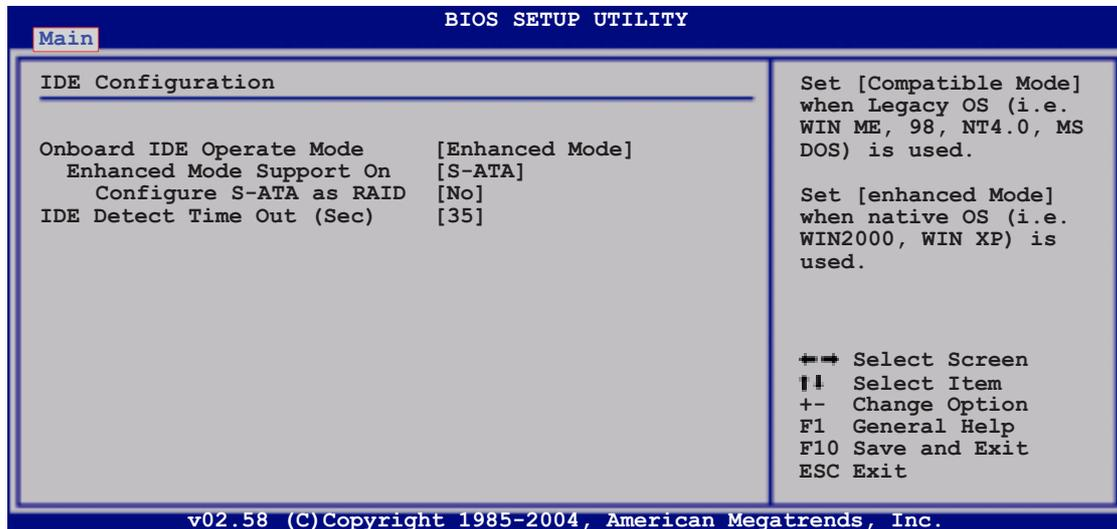

Onboard IDE Operate Mode [Enhanced Mode]

Allows selection of the IDE operation mode depending on the installed operating system (OS). Set to [Enhanced Mode] if you are using native OS, e.g. Windows® 2000/XP. Set to [Compatible Mode] if you are using legacy OS, e.g. Windows ME/98/NT, MS-DOS.

Configuration options: [Compatible Mode] [Enhanced Mode]



The items **Enhanced Mode Support On** and **Configure S-ATA as RAID** appear only when you set the Onboard IDE Operate Mode to [Enhanced Mode].

Enhanced Mode Support On [S-ATA]

Allows you to set Serial ATA, Parallel ATA, or both, to native mode.

Configuration options: [P-ATA+S-ATA] [S-ATA] [P-ATA]

Configure S-ATA as RAID [No]

Allows you to configure the Serial ATA devices as RAID sets.

Configuration options: [No] [Yes]

IDE Detect Time Out (Sec) [35]

Selects the time our value (in seconds) for detecting ATA/ATAPI devices.

Configuration options: [0] [5] [10] [15] [20] [25] [30] [35]

4.3.5 Primary/Secondary IDE Master/Slave, Tertiary and Fourth IDE Master

The BIOS automatically detects the connected IDE devices. There is a separate sub-menu for each IDE device. Select a device item, then press <Enter> to display the IDE device information.

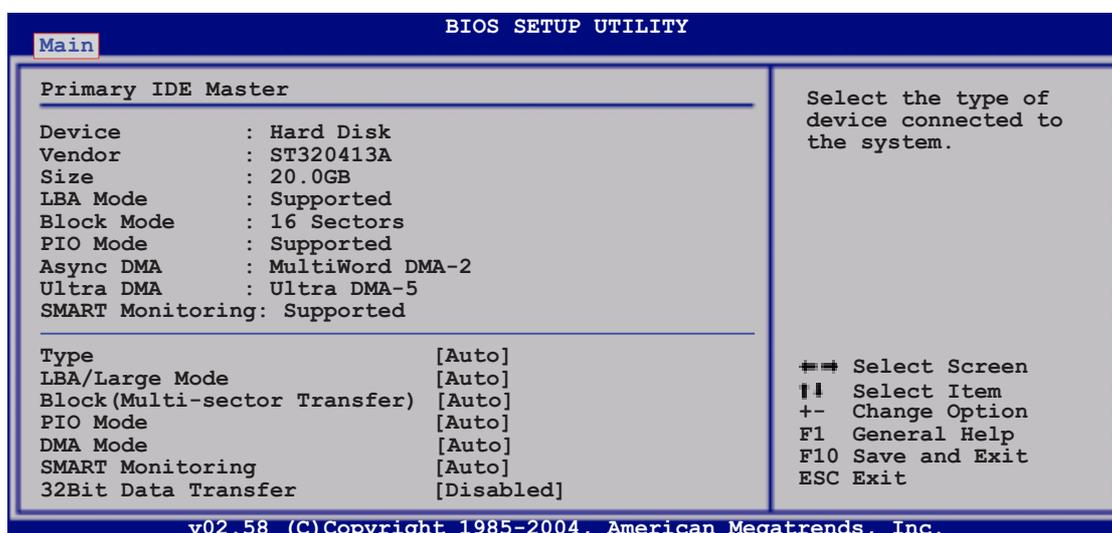

The BIOS automatically detects the values opposite the dimmed items (Device, Vendor, Size, LBA Mode, Block Mode, PIO Mode, Async DMA, Ultra DMA, and SMART monitoring). These values are not user-configurable. These items show N/A if no IDE device is installed in the system.

Type [Auto]

Selects the type of IDE drive. Setting to [Auto] allows automatic selection of the appropriate IDE device type. Select [CDROM] if you are specifically configuring a CD-ROM drive. Select [ARMD] (ATAPI Removable Media Device) if your device is either a ZIP, LS-120, or MO drive. Configuration options: [Not Installed] [Auto] [CDROM] [ARMD]

LBA/Large Mode [Auto]

Enables or disables the LBA mode. Setting to [Auto] enables the LBA mode if the device supports this mode, and if the device was not previously formatted with LBA mode disabled. Configuration options: [Disabled] [Auto]

Block (Multi-sector Transfer) [Auto]

Enables or disables data multi-sectors transfers. When set to [Auto], the data transfer from and to the device occurs multiple sectors at a time if the device supports multi-sector transfer feature. When set to [Disabled], the data transfer from and to the device occurs one sector at a time. Configuration options: [Disabled] [Auto]

PIO Mode [Auto]

Selects the PIO mode. Configuration options: [Auto] [0] [1] [2] [3] [4]

DMA Mode [Auto]

Selects the DMA mode. Configuration options: [Auto] [SWDMA0] [SWDMA1] [SWDMA2] [MWDMA0] [MWDMA1] [MWDMA2] [UDMA0] [UDMA1] [UDMA2]

SMART Monitoring [Auto]

Sets the Smart Monitoring, Analysis, and Reporting Technology. Configuration options: [Auto] [Disabled] [Enabled]

32Bit Data Transfer [Disabled]

Enables or disables 32-bit data transfer. Configuration options: [Disabled] [Enabled]

4.3.6 System Information

This menu gives you an overview of the general system specifications. The BIOS automatically detects the items in this menu.

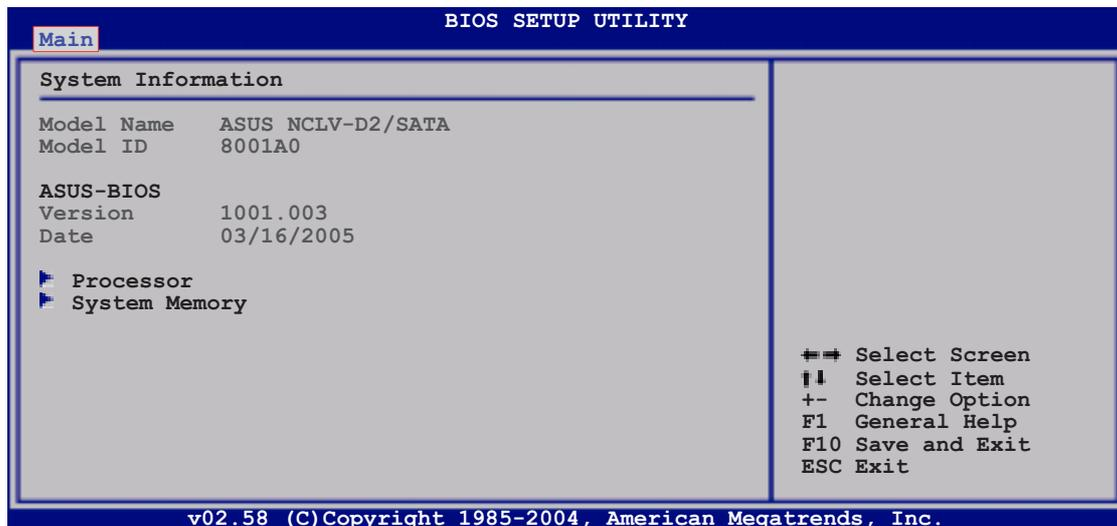

Model Name

Displays the auto-detected ASUS motherboard model (either NCLV-D2/SATA, or NCLV-DS2).

Model ID

Displays the auto-detected identification number of the motherboard.

ASUS BIOS

Displays the auto-detected BIOS version in the motherboard.

Processor Information

Displays the auto-detected information about the installed CPU or CPUs.

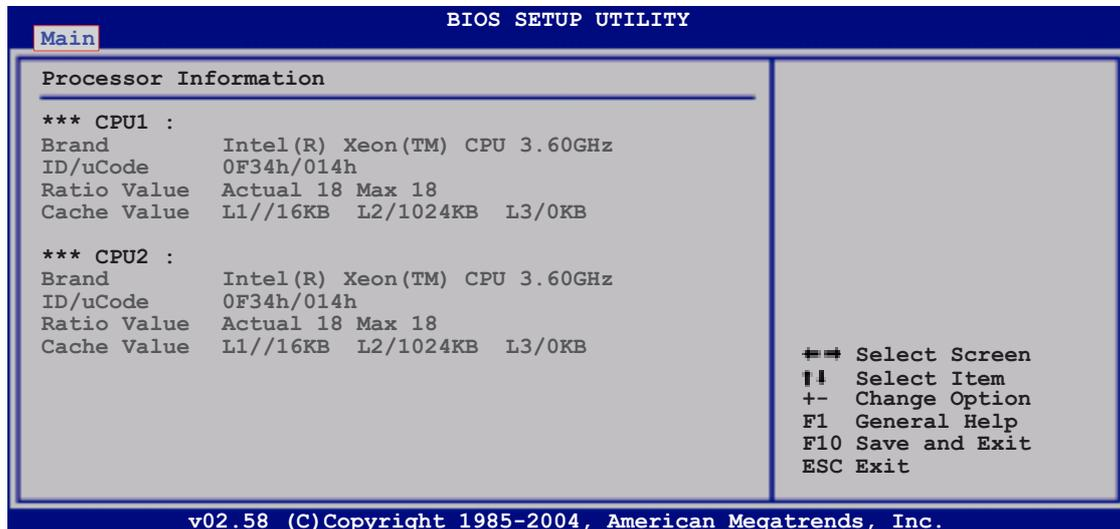

System Memory Information

Displays the auto-detected information about the installed DDR2 DIMMs.

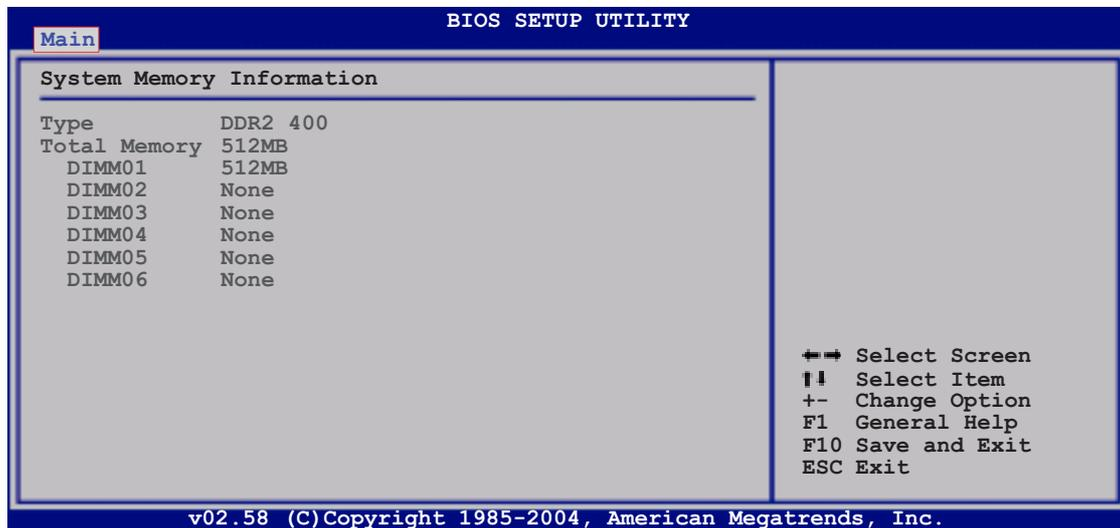

4.4 Advanced menu

The Advanced menu items allow you to change the settings for the CPU and other system devices.



Take caution when changing the settings of the Advanced menu items. Incorrect field values can cause the system to malfunction.

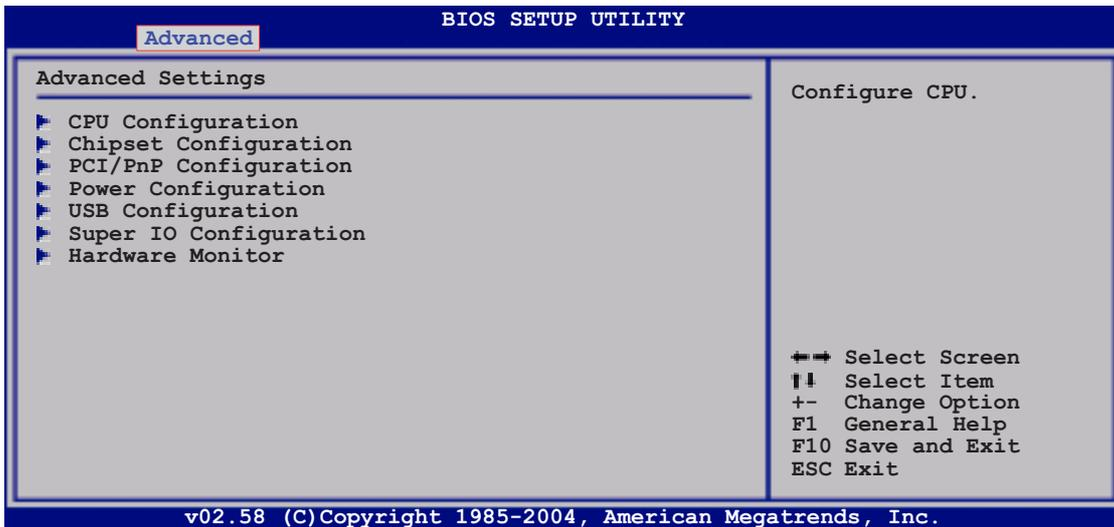

4.4.1 CPU Configuration

The items in this menu show the CPU-related information that the BIOS automatically detects.

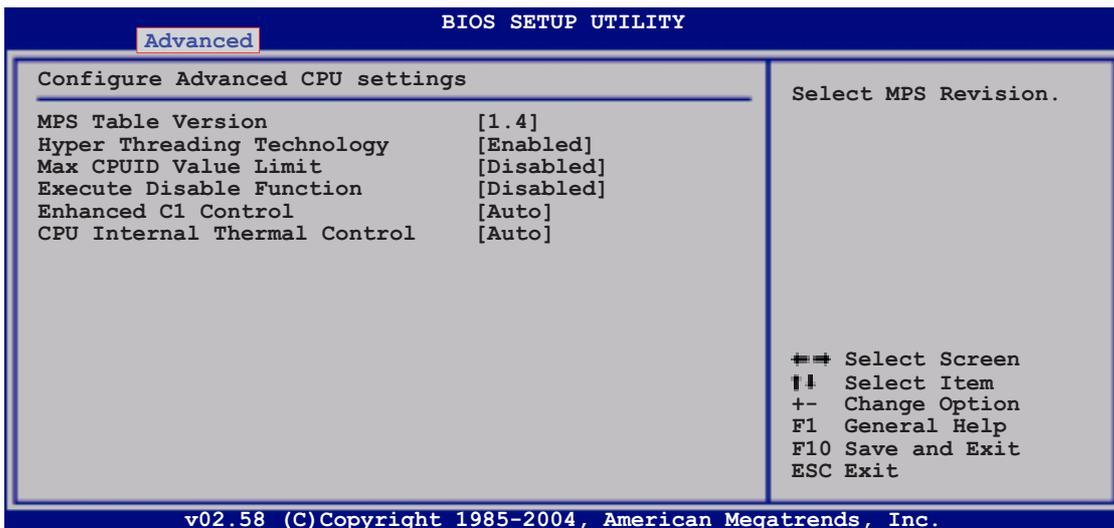

MPS Table Version [1.4]

Allows you to select the multi-processor system version.

Configuration options: [1.1] [1.4]

Hyper Threading Technology [Enabled]

Allows you to enable or disable the processor Hyper-Threading Technology.

Configuration options: [Disabled] [Enabled]

Max CPUID Value Limit [Disabled]

Setting this item to [Enabled] allows legacy operating systems to boot even without support for CPUs with extended CPUID functions.

Configuration options: [Disabled] [Enabled]

Execute Disable Function [Disabled]

When this item is set to [Disabled], the BIOS forces the XD feature flag to always return to (0). Configuration options: [Disabled] [Enabled]

Enhanced C1 Control [Auto]

When this item is set to [Auto], BIOS automatically checks the CPU capability to enable C1E support. In C1E mode, the CPU has lower power consumption. Configuration options: [Auto] [Disabled]

CPU Internal Thermal Control [Auto]

When this item is set to [Auto], BIOS automatically checks the CPU capability to enable TM or TM2 support. In TM mode, the CPU has lower power consumption. In TM2 mode, the CPU core ratio and VID is reduced.

Configuration options: [Auto] [Disabled]

4.4.2 Chipset Configuration

The Chipset Configuration menu allows you to change the advanced chipset settings. Select an item then press <Enter> to display the sub-menu.

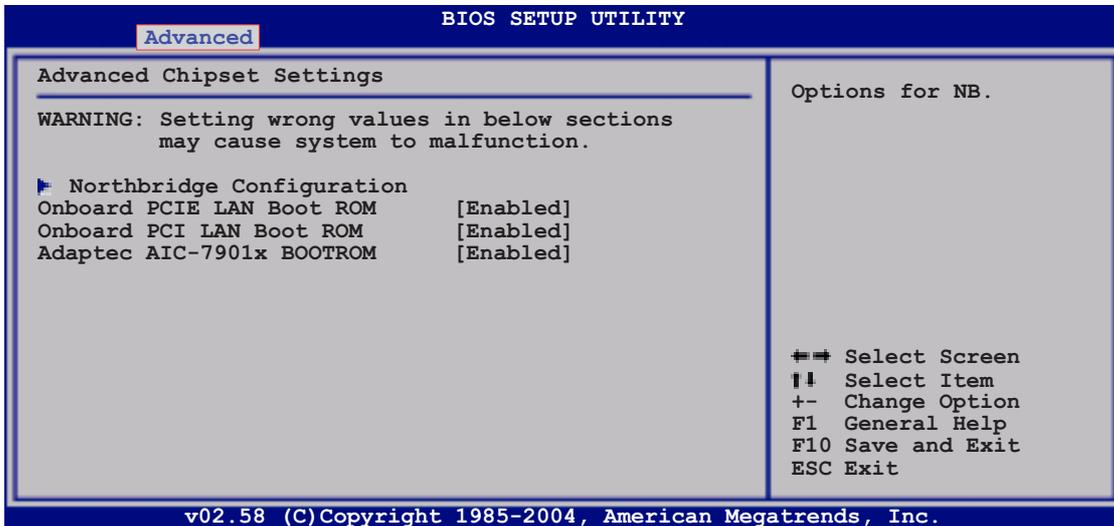

Onboard PCIE LAN Boot ROM [Enabled]

Allows you to enable or disable the option ROM in the onboard LAN controller. Configuration options: [Disabled] [Enabled]

Onboard PCI LAN Boot ROM [Enabled]

Allows you to enable or disable the option ROM in the onboard LAN controller. Configuration options: [Disabled] [Enabled]

Adaptec AIC-7901x BOOTROM [Enabled]

Allows you to enable or disable the option ROM in the onboard SCSI controller. Configuration options: [Disabled] [Enabled]



The Adaptec AIC-7901x BOOTROM item appears only on SCSI model.

NorthBridge Configuration

The NorthBridge Configuration menu allows you to change the Northbridge related settings.

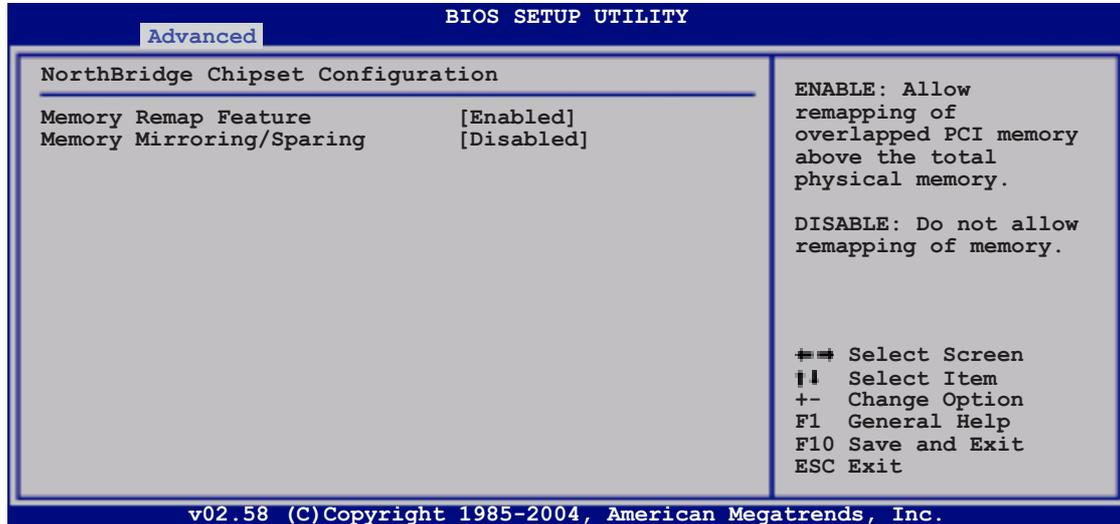

Memory Remap Feature [Enabled]

Allows you to remap the overlap PCI memory over the total physical memory. Configuration options: [Disabled] [Enabled]

Memory Mirroring/Sparing [Disabled]

Allows you to select the memory RAS feature: mirroring or sparing. Configuration options: [Disabled] [Mirroring] [Sparing]

4.4.3 PCI/PnP Configuration

The PCI/PnP Configuration menu items allow you to change the advanced settings for PCI/PnP devices. The menu includes setting the IRQ and DMA channel resources for either PCI/PnP or legacy ISA devices, and setting the memory size block for legacy ISA devices.



Take caution when changing the settings of the PCI PnP menu items. Incorrect field values can cause the system to malfunction!

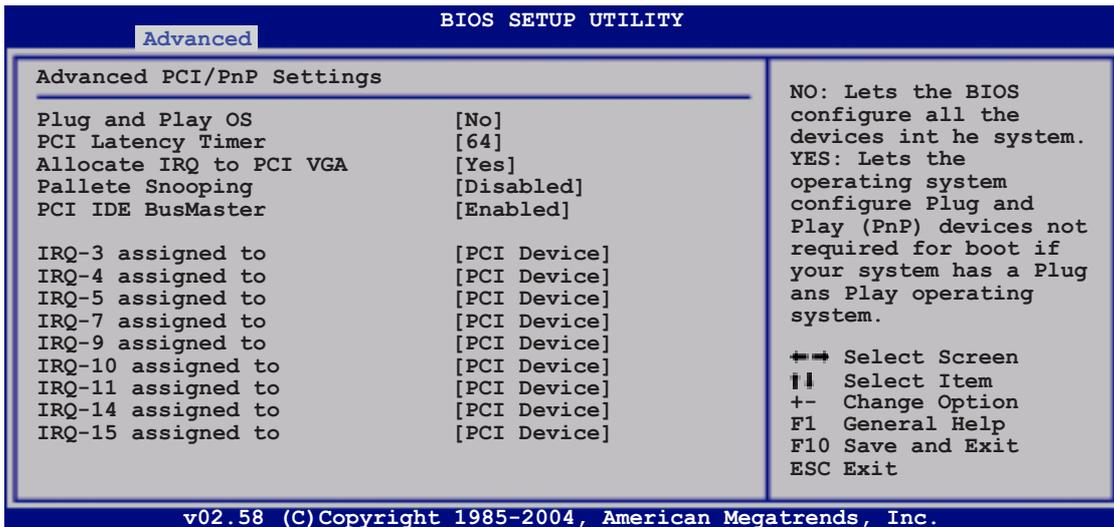

Plug And Play O/S [No]

When set to [No], BIOS configures all the devices in the system. When set to [Yes] and if you install a Plug and Play operating system, the operating system configures the Plug and Play devices not required for boot.

Configuration options: [No] [Yes]

PCI Latency Timer [64]

Allows you to select the value in units of PCI clocks for the PCI device latency timer register. Configuration options: [32] [64] [96] [128] [160] [192] [224] [248]

Allocate IRQ to PCI VGA [Yes]

When set to [Yes], BIOS assigns an IRQ to PCI VGA card if the card requests for an IRQ. When set to [No], BIOS does not assign an IRQ to the PCI VGA card even if requested. Configuration options: [Yes] [No]

Palette Snooping [Disabled]

When set to [Enabled], the palette snooping feature informs the PCI devices that an ISA graphics device is installed in the system so that the latter can function correctly. Configuration options: [Disabled] [Enabled]

PCI IDE BusMaster [Enabled]

Allows BIOS to use PCI bus mastering when reading/writing to IDE devices.
Configuration options: [Disabled] [Enabled]

IRQ-xx assigned to [PCI Device]

When set to [PCI Device], the specific IRQ is free for use of PCI/PnP devices. When set to [Reserved], the IRQ is reserved for legacy devices.
Configuration options: [PCI Device] [Reserved]

4.4.4 Power Configuration

The Power Configuration menu items allow you to change the settings for the ACPI and Advanced Power Management (APM) features. Select an item then press <Enter> to display the configuration options.

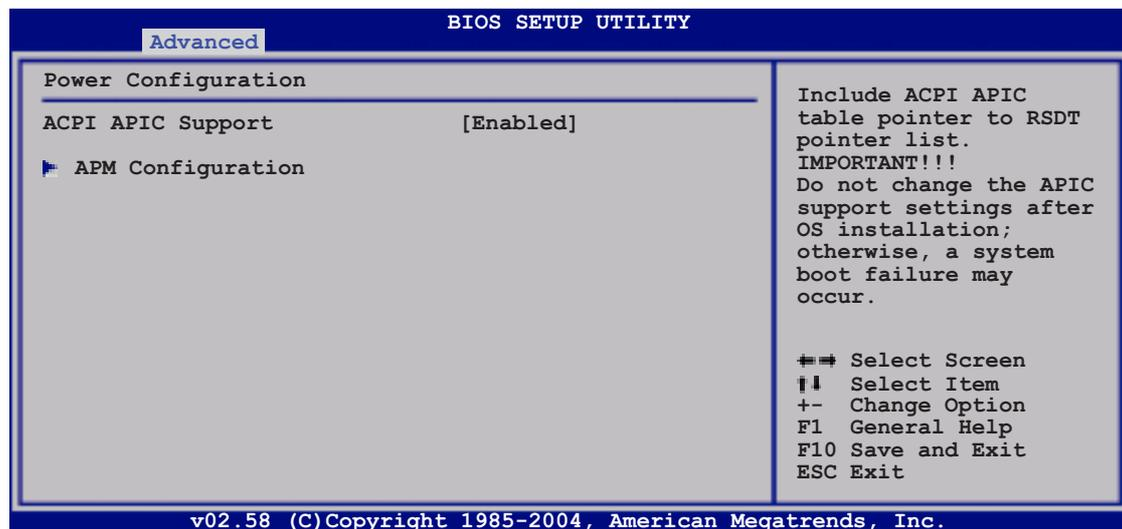

ACPI APIC Support [Enabled]

Allows you to enable or disable the Advanced Configuration and Power Interface (ACPI) support in the Application-Specific Integrated Circuit (ASIC). When set to Enabled, the ACPI APIC table pointer is included in the RSDT pointer list. Configuration options: [Disabled] [Enabled]

APM Configuration

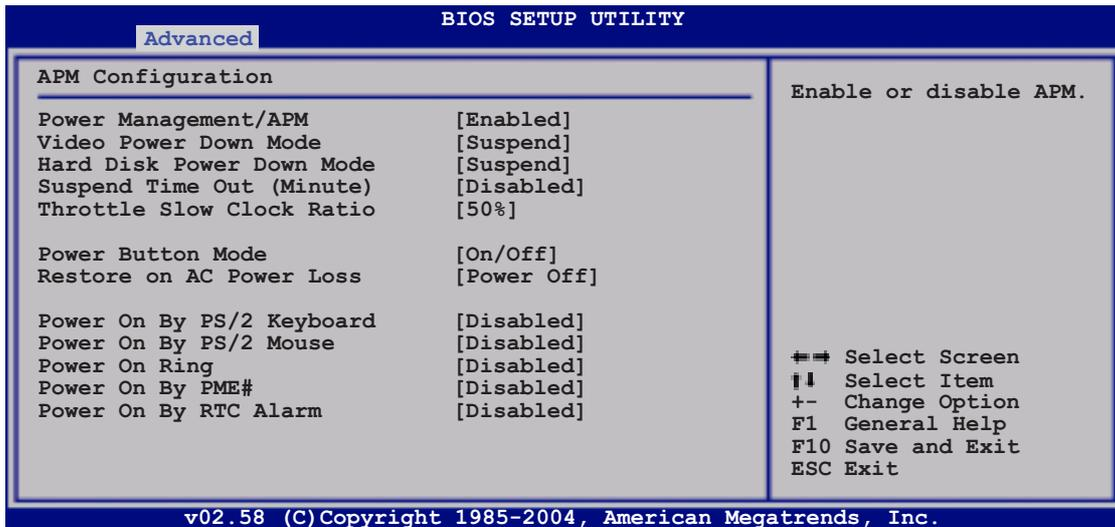

Power Management [Enabled]

Allows you to enable or disable the motherboard Advance Power Management (APM) feature. Configuration options: [Enabled] [Disabled]

Video Power Down Mode [Suspend]

Allows you to select the video power down mode
Configuration options: [Disabled] [Standby] [Suspend]

Hard Disk Power Down Mode [Suspend]

Allows you to select the hard disk power down mode
Configuration options: [Disabled] [Standby] [Suspend]

Suspend Time Out (Minute) [Disabled]

Allows you to select the specified time at which the system goes on suspend mode. Configuration options: [Disabled] [1 Min] [2 Min] [4 Min] [8 Min] [10 Min] [20 Min] [30 Min] [40 Min] [50 Min] [60 Min]

Throttle Slow Clock Ratio [50%]

Allows you to select duty cycle in throttle mode.
Configuration options: [87.5%] [75.0%] [62.5%] [50.0%] [37.5%] [25.0%] [12.5%]

Power Button Mode [On/Off]

Allows the system to go into On/Off mode or suspend mode when the power button is pressed. Configuration options: [On/Off] [Suspend]

Restore on AC Power Loss [Power Off]

When set to Power Off, the system goes into off state after an AC power loss. When set to Power On, the system goes on after an AC power loss. When set to Last State, the system goes into either off or on state, whatever the system state was before the AC power loss.
Configuration options: [Power Off] [Power On] [Last State]

Power On By PS/2 Keyboard [Disabled]

Allows you to use specific keys on the keyboard to turn on the system. This feature requires an ATX power supply that provides at least 1A on the +5VSB lead. Configuration options: [Disabled] [Enabled]

Power On By PS/2 Mouse [Disabled]

When set to [Enabled], this parameter allows you to use the PS/2 mouse to turn on the system. This feature requires an ATX power supply that provides at least 1A on the +5VSB lead. Configuration options: [Disabled] [Enabled]

Power On Ring [Disabled]

When set to [Enabled], the system enables the RI to generate a wake event while the computer is in Soft-off mode.
Configuration options: [Disabled] [Enabled]

Power On By PME# [Disabled]

When set to [Enabled], the system enables the PME to generate a wake event while the computer is in Soft-off mode.
Configuration options: [Disabled] [Enabled]

Power On By RTC Alarm [Disabled]

Allows you to enable or disable RTC to generate a wake event. When this item is set to [Enabled], the items RTC Alarm Date, RTC Alarm Hour, RTC Alarm Minute, and RTC Alarm Second appear with set values.
Configuration options: [Disabled] [Enabled]

4.4.5 USB Configuration

The items in this menu allows you to change the USB-related features. Select an item then press <Enter> to display the configuration options.

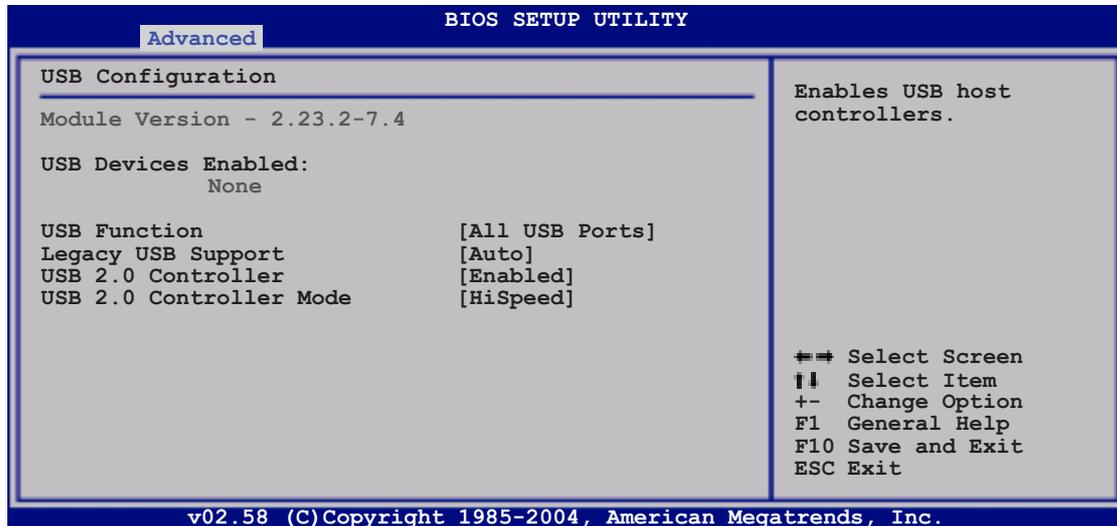

The **Module Version** and **USB Devices Enabled** items show the auto-detected values. If no USB device is detected, the **USB Devices Enabled** item shows **None**.

USB Function [All USB Ports]

Allows you to enable a specific number of USB ports, or disable the USB function. Configuration options: [Disabled] [2 USB Ports] [All USB Ports]

Legacy USB Support [Auto]

Allows you to enable or disable support for legacy USB devices. Setting to [Auto] allows the system to detect the presence of legacy USB devices at startup. If detected, the USB controller legacy mode is enabled. If no legacy USB device is detected, the legacy USB support is disabled. Configuration options: [Disabled] [Enabled] [Auto]

USB 2.0 Controller [Enabled]

Allows you to enable or disable the USB 2.0 controller. Configuration options: [Enabled] [Disabled]

USB 2.0 Controller Mode [HiSpeed]

Allows you to set the USB 2.0 controller mode to HiSpeed (480 Mbps) or FullSpeed (12 Mbps). Configuration options: [FullSpeed] [HiSpeed]

4.4.6 Super IO Configuration

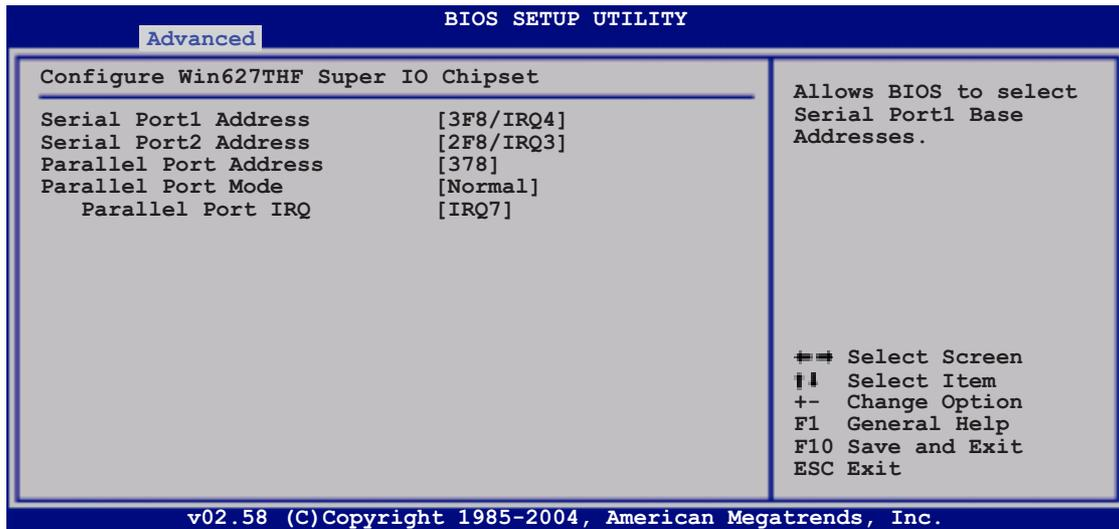

Serial Port1 Address [3F8/IRQ4]

Allows you to select the Serial Port1 base address.

Configuration options: [Disabled] [3F8/IRQ4] [3E8/IRQ4] [2E8/IRQ3]

Serial Port2 Address [2F8/IRQ3]

Allows you to select the Serial Port2 base address.

Configuration options: [Disabled] [2F8/IRQ3] [3E8/IRQ4] [2E8/IRQ3]

Parallel Port Address [378]

Allows you to select the Parallel Port base addresses.

Configuration options: [Disabled] [378] [278] [3BC]

Parallel Port Mode [Normal]

Allows you to select the Parallel Port mode. Configuration options: [Normal] [Bi-Directional] [EPP] [ECP]

Parallel Port IRQ [IRQ7]

Allows you to select the Parallel Port IRQ.

[Configuration options: [IRQ5] [IRQ7]

4.4.7 Hardware Monitor

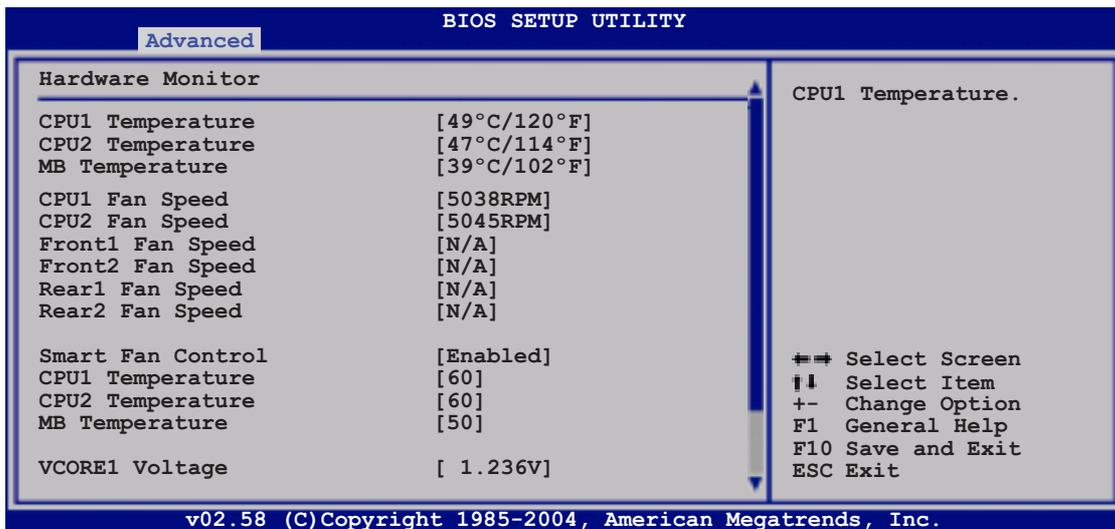

Use the down arrow key to display additional items.



CPU1/CPU2 Temperature [xxx°C/xxx°F]

MB Temperature [xxx°C/xxx°F]

The onboard hardware monitor automatically detects and displays the motherboard and CPU temperatures. Select [Disabled] if you do not wish to display the detected temperatures.

CPU1/CPU2 Fan Speed [xxxxRPM] or [N/A]

Front1/Front2 Fan Speed [xxxxRPM] or [N/A]

Rear1/Rear2 Fan Speed [xxxxRPM] or [N/A]

The onboard hardware monitor automatically detects and displays the CPU, front, and rear fan speeds in rotations per minute (RPM). If a fan is not connected to the connector on the motherboard, the field shows N/A.

Smart Fan Control [Enabled]

Allows you to enable or disable the ASUS Smart Fan Control feature that smartly adjusts the fan speeds for more efficient system operation.

Configuration options: [Disabled] [Enabled]



The **CPU1 Temperature**, **CPU2 Temperature**, and **MB Temperature** items do not appear when you disable the **Smart Fan Control** feature.

CPU1/CPU2 Temperature [XXX] MB Temperature [XXX]

Displays the detected CPU and system threshold temperatures when the Smart Fan Control feature is enabled.

VCORE1 Voltage, VCORE2 Voltage, 3.3V Voltage, 5V Voltage, 5VSB Voltage, VBAT Voltage, 12V Voltage

The onboard hardware monitor automatically detects the voltage outputs through the onboard voltage regulators.

4.5 Server menu

The Server menu items allow you to customize the server features.

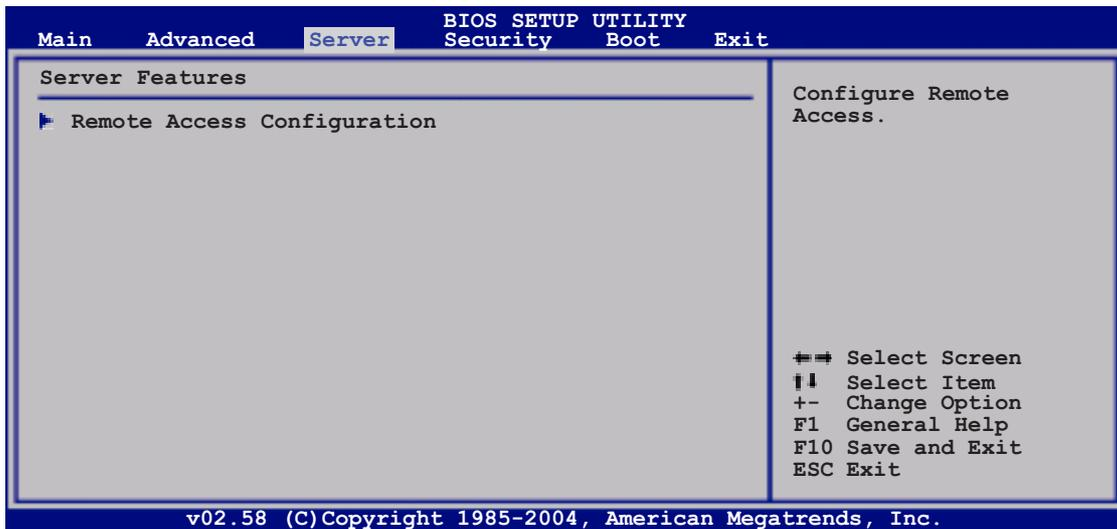

4.5.1 Remote Access Configuration

The items in this menu allows you to configure the Remote Access features. Select an item then press <Enter> to display the configuration options.

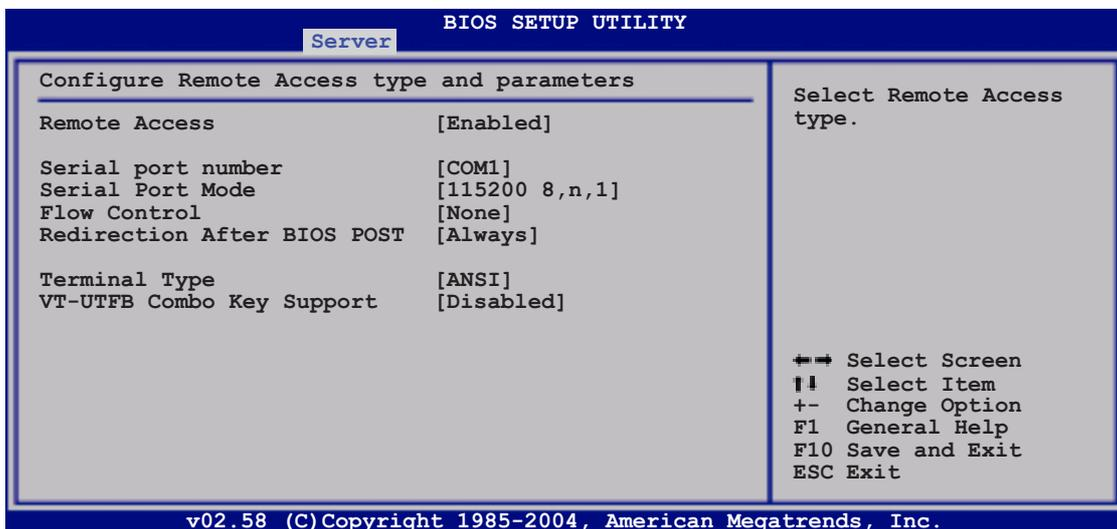

When the **Remote Access** item is set to [Disabled], all the other items do not appear.

Remote Access [Enabled]

Enables or disables the remote access feature. Setting this item to [Enabled] displays other connectivity items (see the screen below).
Configuration options: [Disabled] [Enabled]

Serial port number [COM1]

Enables or disables the remote access feature.
Configuration options: [Disabled] [Enabled]

Serial Port Mode [115200 8,n,1]

Sets the Serial port mode.
Configuration options: [115200 8,n,1] [57600 8,n,1] [38400 8,n,1]
[19200 8,n,1] [09600 8,n,1]

Flow Control [None]

Allows you to select the flow control for console redirection.
Configuration options: [None] [Hardware] [Software]

Redirection After BIOS POST [Always]

Sets the redirection mode after the BIOS Power-On Self-Test (POST). Some operating systems may not work when this item is set to Always.
Configuration options: [Disabled] [Boot Loader] [Always]

Terminal Type [ANSI]

Allows you to select the target terminal type.
Configuration options: [ANSI] [VT100] [VT-UTF8]

VT-UTF8 Combo Key Support [Disabled]

Enables or disables the VT-UTF8 combo key support for ANSI or VT100 terminals. Configuration options: [Disabled] [Enabled]

4.6 Security

The Security menu items allow you to change the system security settings. Select an item then press <Enter> to display the configuration options.

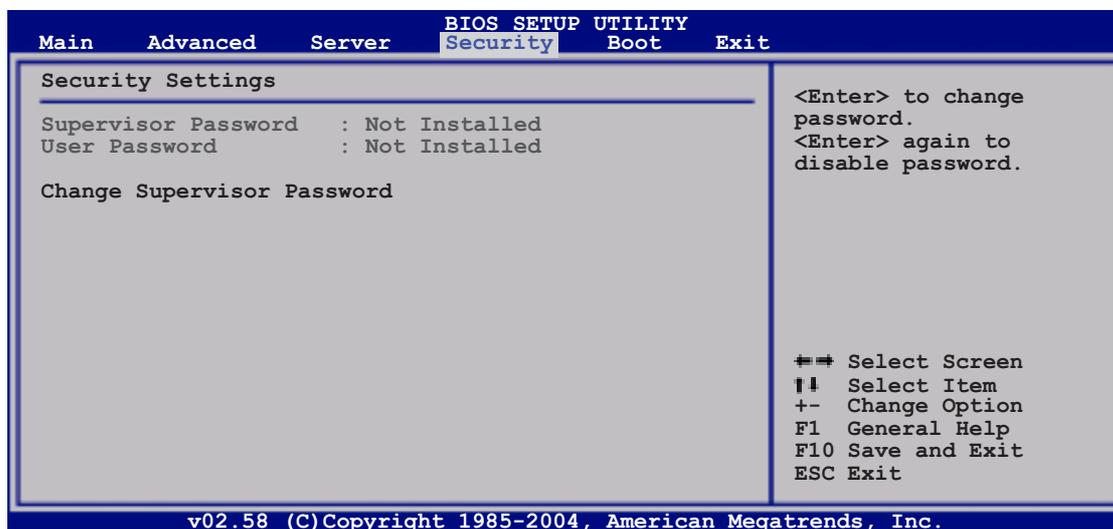

Change Supervisor Password

Select this item to set or change the supervisor password. The Supervisor Password item on top of the screen shows the default **Not Installed**. After you set a password, this item shows **Installed**.

To set or change a supervisor password:

1. Select the **Change Supervisor Password** item, then press <Enter>.
2. From the password box, type a password composed of at least six letters and/or numbers, then press <Enter>.
3. Confirm the password when prompted.

The message "Password Installed" appears after you successfully set your password.

To change the supervisor password, follow the same steps as in setting a user password.

To clear the supervisor password:

Select the **Change Supervisor Password** then press <Enter>. The message "Password Uninstalled" appears.



If you forget your BIOS password, you can clear it by erasing the CMOS Real Time Clock (RTC) RAM. See section "2.6 Jumpers" for information on how to erase the RTC RAM.

After you have set a supervisor password, the other items appear to allow you to change other security settings.

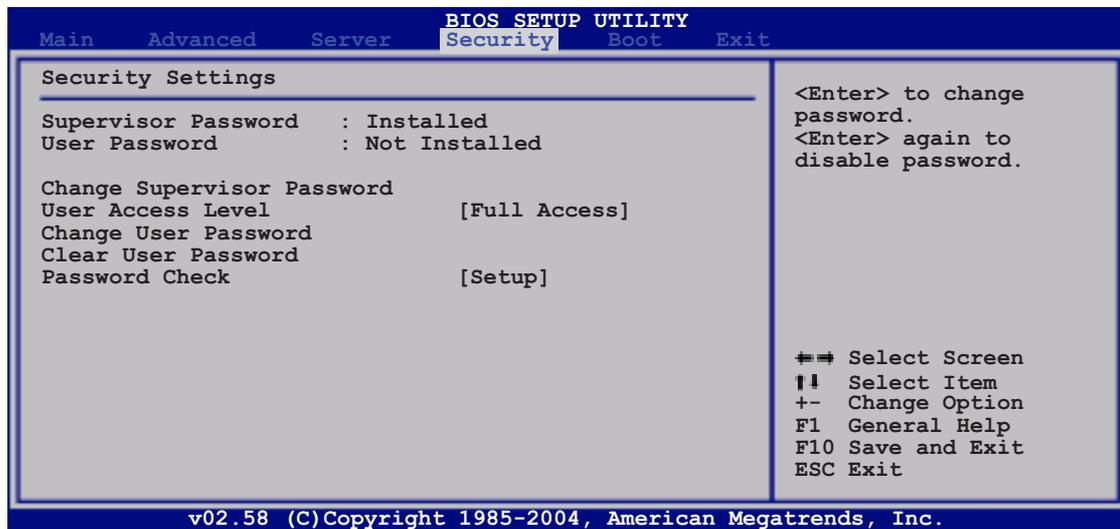

User Access Level [Full Access]

This item allows you to select the access restriction to the Setup items. Configuration options: [No Access] [View Only] [Limited] [Full Access]

No Access prevents user access to the Setup utility.

View Only allows access but does not allow change to any field.

Limited allows changes only to selected fields, such as Date and Time.

Full Access allows viewing and changing all the fields in the Setup utility.

Change User Password

Select this item to set or change the user password. The **User Password** item on top of the screen shows the default **Not Installed**. After you set a password, this item shows **Installed**.

To set a user password:

1. Select the Change User Password item and press <Enter>.
2. On the password box that appears, type a password composed of at least six letters and/or numbers, then press <Enter>.
3. Confirm the password when prompted.

The message "Password Installed" appears after you set your password successfully.

To change the user password, follow the same steps as in setting a user password.

Clear User Password

Select this item to clear the user password.

Password Check [Setup]

When set to [Setup], BIOS checks for user password when accessing the Setup utility. When set to [Always], BIOS checks for user password both when accessing Setup and booting the system.

Configuration options: [Setup] [Always]

4.7 Boot menu

The Boot menu items allow you to change the system boot options. Select an item then press <Enter> to display the sub-menu.

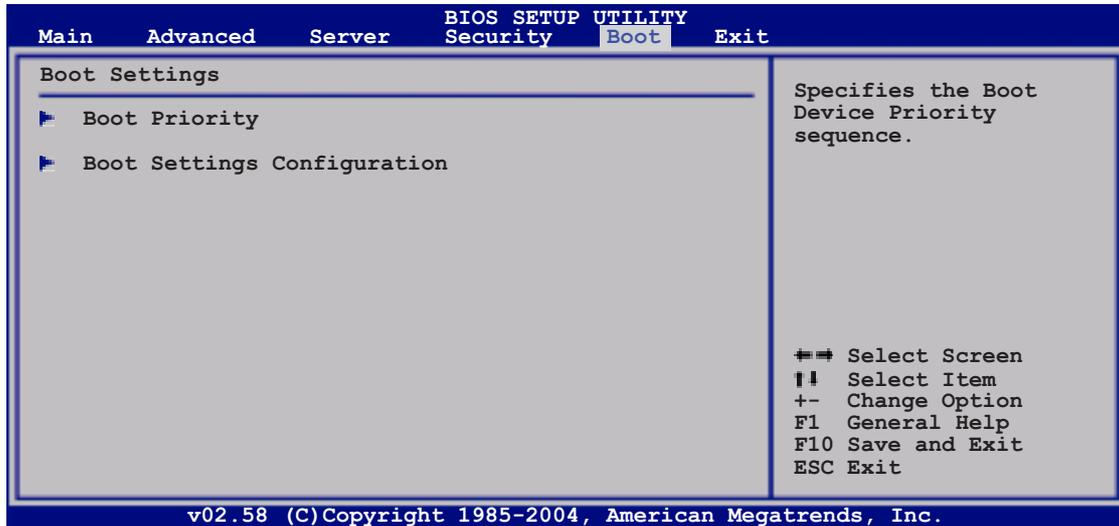

4.7.1 Boot Device Priority

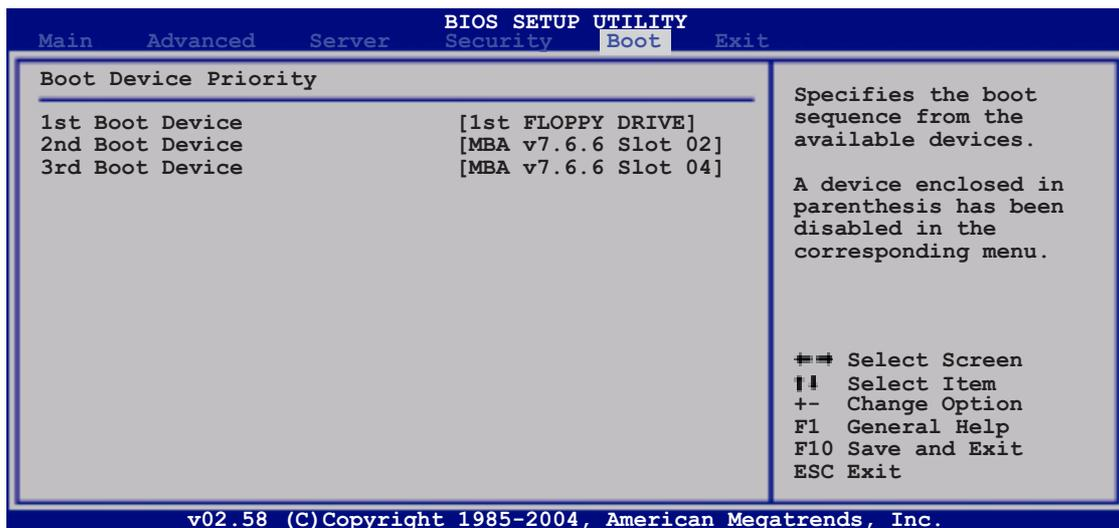

1st Boot Device [1st FLOPPY DRIVE]
2nd Boot Device [MBA v7.6.6 Slot 02]
3rd Boot Device [MBA v7.6.6 Slot 04]

These items specify the boot device priority sequence from the available devices. Configuration options: [1st FLOPPY DRIVE] [MBA v7.6.6 Slot 02] [MBA v7.6.6 Slot 04] [Disabled]

4.7.2 Boot Settings Configuration

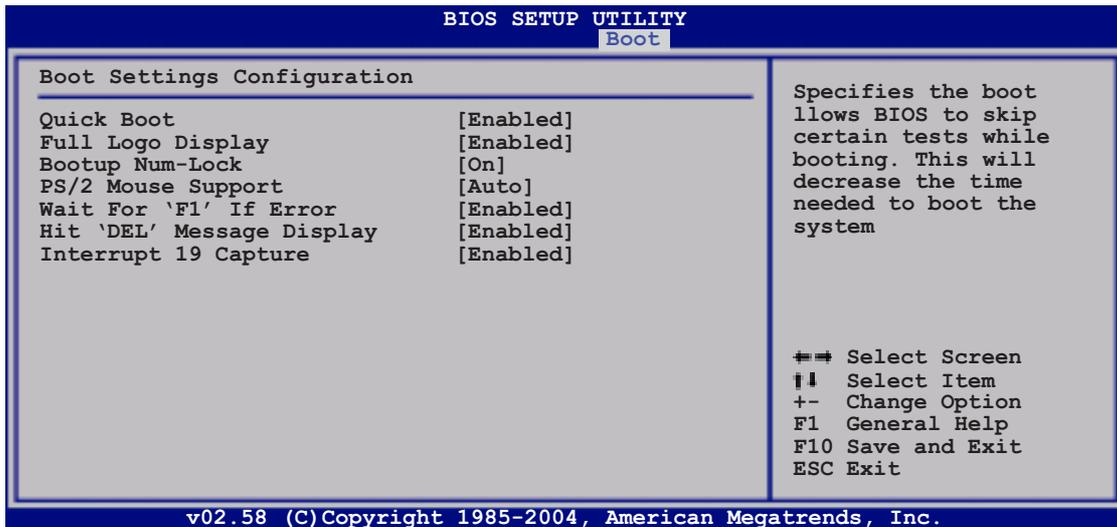

Quick Boot [Enabled]

Enabling this item allows the BIOS to skip some power on self tests (POST) while booting to decrease the time needed to boot the system. When set to [Disabled], BIOS performs all the POST items.

Configuration options: [Disabled] [Enabled]

Full Logo display [Enabled]

Allows you to enable or disable the full screen logo display feature.

Configuration options: [Disabled] [Enabled]



Set this item to [Enabled] to use the ASUS MyLogo2™ feature.

Bootup Num-Lock [On]

Allows you to select the power-on state for the NumLock.

Configuration options: [Off] [On]

PS/2 Mouse Support [Auto]

Allows you to enable or disable support for PS/2 mouse.

Configuration options: [Disabled] [Enabled] [Auto]

Wait for 'F1' If Error [Enabled]

When set to Enabled, the system waits for the F1 key to be pressed when error occurs. Configuration options: [Disabled] [Enabled]

Hit 'DEL' Message Display [Enabled]

When set to Enabled, the system displays the message "Press DEL to run Setup" during POST. Configuration options: [Disabled] [Enabled]

Interrupt 19 Capture [Enabled]

When set to [Enabled], this function allows the option ROMs to trap Interrupt 19. Configuration options: [Disabled] [Enabled]

4.8 Exit menu

The Exit menu items allow you to load the optimal or failsafe default values for the BIOS items, and save or discard your changes to the BIOS items.

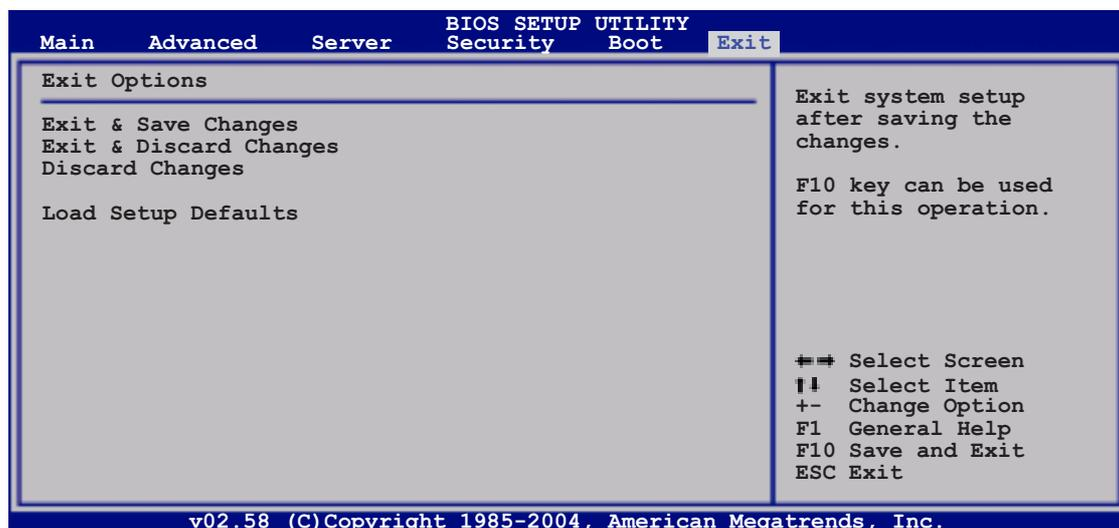

If you made changes to any of the settings in the menus, pressing <Esc> does not immediately exit this menu. A confirmation window appears and prompts you to either save your changes or cancel the command. Select one of the options from this menu to exit.

Exit & Save Changes

Select this option then press <Enter>, or simply press <F10>, to save your changes to CMOS before exiting the Setup utility.

When a confirmation window appears, select [OK] then press <Enter> to save your changes and exit Setup. If you wish to cancel the command, select [Cancel] then press <Enter> to return to the Exit menu.

Exit & Discard Changes

Select this option then press <Enter> to exit the Setup utility without saving your changes.

When a confirmation window appears, select [OK] then press <Enter> to discard your changes and exit Setup. If you wish to cancel the command, select [Cancel] then press <Enter> to return to the Exit menu.

Discard Changes

Select this option then press <Enter> to discard the changes that you made, and restore the previously saved settings.

When a confirmation window appears, select [OK] then press <Enter> to discard the changes, and load the previously saved settings. If you wish to cancel the command, select [Cancel] then press <Enter> to return to the Exit menu.

Load Setup Defaults

Select this option then press <Enter> to load the optimized settings for each of the Setup menu items.

When a confirmation window appears, select [OK] then press <Enter> to load the default settings. If you wish to cancel the command, select [Cancel] then press <Enter> to return to the Exit menu.

This chapter provides instructions for setting up, creating, and configuring RAID sets using the available utilities.

5 RAID configuration

5.1	Setting up RAID	5-1
5.2	LSI Logic Embedded SATA RAID Setup Utility	5-4
5.3	Global Array Manager	5-26
5.4	Adaptec® SCSISelect(TM) Utility (NCLV-DS2 model only)	5-27
5.5	Adaptec® RAID Configuration Utility (NCLV-D2/SATA model only)	5-48

5.1 Setting up RAID

The motherboard comes with the following RAID solutions:

NCLV-D2/SATA model

- **LSI Logic Embedded SATA RAID** controller in the Intel® 6300ESB Southbridge supports up to two SATA hard disk drives and RAID 0 or RAID 1 configuration.
- **Adaptec® AIC-8130 PCI-X SATAII** controller supports four SATA hard disk drives and RAID 0, RAID 1, and RAID 0+1 configurations.

NCLV-DS2 model

- **LSI Logic Embedded SATA RAID** controller in the Intel® 6300ESB Southbridge supports up to two SATA hard disk drives and RAID 0 or RAID 1 configuration.
- **Adaptec® AIC-7901X PCI-X SCSI** controller supports SCSI hard disk drives and RAID 0, RAID 1, and RAID 0+1 configurations.

5.1.1 RAID definitions

RAID 0 (*Data striping*) optimizes two identical hard disk drives to read and write data in parallel, interleaved stacks. Two hard disks perform the same work as a single drive but at a sustained data transfer rate, double that of a single disk alone, thus improving data access and storage. Use of two new identical hard disk drives is required for this setup.

RAID 1 (*Data mirroring*) copies and maintains an identical image of data from one drive to a second drive. If one drive fails, the disk array management software directs all applications to the surviving drive as it contains a complete copy of the data in the other drive. This RAID configuration provides data protection and increases fault tolerance to the entire system. Use two new drives or use an existing drive and a new drive for this setup. The new drive must be of the same size or larger than the existing drive.

RAID 0+1 is *data striping* and *data mirroring* combined without parity (redundancy data) having to be calculated and written. With the RAID 0+1 configuration you get all the benefits of both RAID 0 and RAID 1 configurations. Use four new hard disk drives or use an existing drive and three new drives for this setup.

JBOD (*Spanning*) stands for **Just a Bunch of Disks** and refers to hard disk drives that are not yet configured as a RAID set. This configuration stores the same data redundantly on multiple disks that appear as a single disk on the operating system. Spanning does not deliver any advantage over using separate disks independently and does not provide fault tolerance or other RAID performance benefits.

5.1.2 Installing hard disk drives

The motherboard supports both Serial ATA and SCSI (NCLV-DS2 model only) hard disk drives for RAID configuration. For optimal performance, install identical drives of the same model and capacity when creating a disk array.

To install the SATA hard disks for RAID configuration:

1. Install the SATA hard disks into the drive bays following the instructions in the system user guide.
2. Connect a SATA signal cable to the signal connector at the back of each drive and to the SATA connector on the motherboard.
3. Connect a SATA power cable to the power connector on each drive.

To install the SCSI hard disks for RAID configuration:

1. Install the SCSI hard disks into the drive bays following the instructions in the system user guide.
2. Connect the SCSI interface cable connectors at the back of the SCSI drives.
3. Connect the other end of the SCSI interface cable to the SCSI connector on the motherboard.

5.1.3 Setting the RAID item in BIOS

You must set the RAID item in the BIOS Setup before you can create a RAID set from SATA hard disk drives attached to the SATA connectors supported by the Intel® 6300ESB Southbridge chip. To do this:

1. Enter the BIOS Setup during POST.
2. Go to the **Main Menu**, select **IDE Configuration**, then press <Enter>.
3. Set the **Onboard IDE Operate** item to [Enhanced Mode], then press <Enter>.
4. Set the **Enhanced Mode Support On** item to [S-ATA], then set the **Configure S-ATA as RAID** item to [Yes].
5. Save your changes, then exit the BIOS Setup.



Refer to Chapter 4 for details on entering and navigating through the BIOS Setup.

5.1.4 RAID configuration utilities

Depending on the RAID connectors that you use, you can create a RAID set using the utilities embedded in each RAID controller. For example, use the **LSI Logic Embedded SATA RAID Setup Utility** if you installed SATA hard disk drives on the SATA connectors supported by the Intel® 6300ESB Southbridge and/or the **Adaptec SCSISelect (TM) Utility!** if you installed SCSI hard disk drives to the SCSI connector supported by the Adaptec® AIC-7901X RAID controller (NCLV-DS2 model only). Refer to the succeeding sections for details on how to use each RAID configuration utility.



If you want to boot the system from a hard disk drive included in a created RAID set, copy first the RAID driver from the support CD to a floppy disk before you install an operating system to the selected hard disk drive. Refer to Chapter 6 for details.

5.2 LSI Logic Embedded SATA RAID Setup Utility

The LSI Logic Embedded SATA RAID Setup Utility allows you to create RAID 0 and RAID 1 set(s) from SATA hard disk drives connected to the SATA interfaces supported by the Intel® 6300ESB Southbridge chip.

To enter the LSI Logic Embedded SATA RAID Setup Utility:

1. Turn on the system after installing all the SATA hard disk drives.
2. During POST, the LSI Logic Embedded SATA RAID Setup Utility automatically detects the installed SATA hard disk drives and displays any existing RAID set(s). Press <Ctrl> + <M> to enter the utility.

```
LSI Logic Embedded SATA RAID BIOS Version 5.4.05091647R
(c)2004 Copyright LSI Logic Corporation. All Rights Reserved.

LSI Logic Embedded SATA RAID Found at PCI Bus No:00 Dev No:1F
Scanning for Port 0 ... Responding. HDS722512WLSA00 117800MB UDMA 5
Scanning for Port 1 ... Responding. HDS722512WLSA00 117800MB UDMA 5

01 Logical drive(s) Configured.
Array# Mode Stripe Size No.Of Stripes DriveSize Status
00 Reliability 64KB(128 Sectors) 02 114376MB Online

Press Ctrl-M to run LSI Logic Embedded SATA RAID Setup Utility.
```



The LSI Logic Embedded SATA RAID auto configures to RAID 1 when the SATA to RAID Mode is enabled.

3. The utility main window appears. Use the arrow keys to select an option from the **Management Menu**, then press <Enter>. Refer to the Management Menu descriptions on the next page.

At the bottom of the screen is the legend box. The keys on the legend box allow you to navigate through the setup menu options or execute commands. The keys on the legend box vary according to the menu level.

```
-----
** Management Menu **
- Configure
- Initialize
- Objects
- Rebuild
- Check Consistency
-----

-----
- Configure Logical Drive(s)
-----

Use Cursor Keys To Navigate Between Items And Press Enter To Select An Option
```

- The **ARRAY SELECTION MENU** displays the available drives connected to the SATA ports. Select the drives you want to include in the RAID set, then press <SpaceBar>. When selected, the drive indicator changes from **READY** to **ONLIN A[X]-[Y]**, where X is the array number, and Y is the drive number.

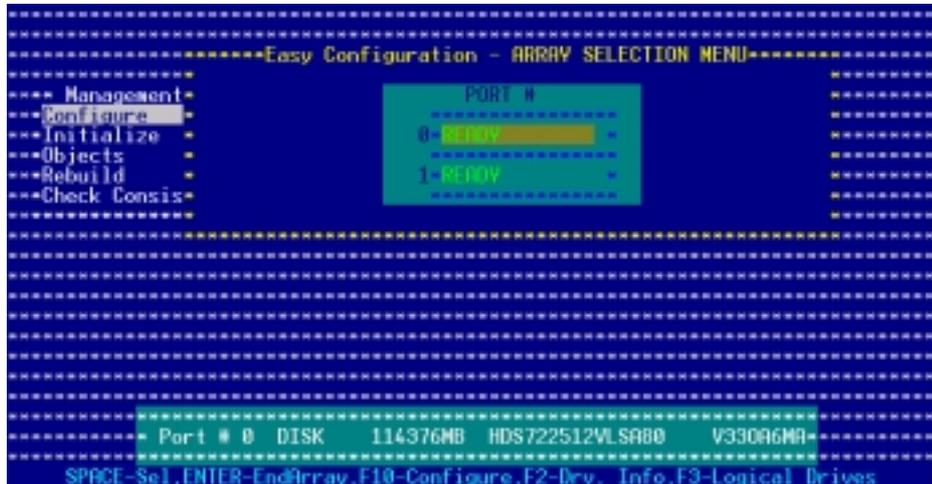

The information of the selected hard disk drive displays at the bottom of the screen.

- Select all the drives required for the RAID set, then press <Enter>. The configurable array appears on screen.

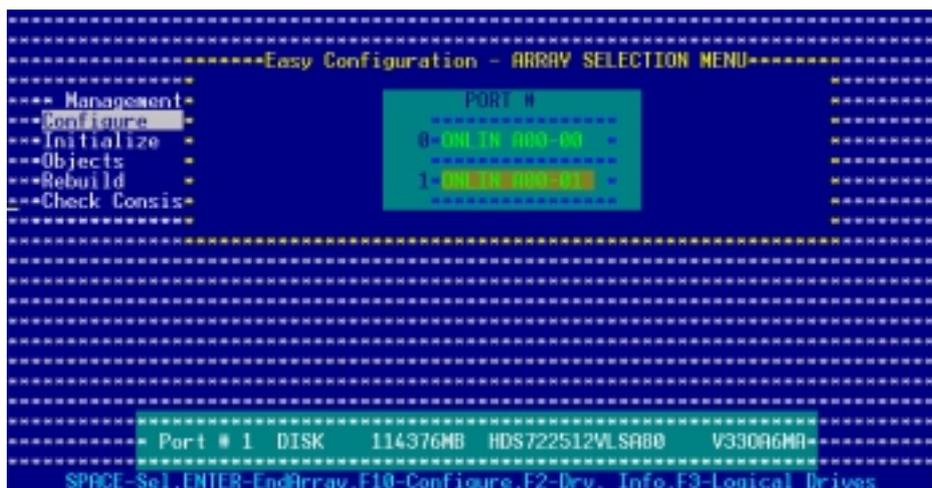

6. Select **RAID** from the **Logical Drive** menu, then press <Enter>.
7. Select the RAID level from the menu, then press <Enter>.



You need at least two identical hard disk drives when creating a RAID 1 set.

```

===== Logical Drive(s) Configured =====
===== LD   RAID   Size   #Stripes   StripeSz   Status =====
===== 0    1     114376MB 2         64 KB     ONLINE =====
--*-- Manage
--*-- Config
--*-- Initializ
--*-- Objects
--*-- Rebuild
--*-- Check Con
=====
--*-- Logical Drive 0
--*-- RAID = 1
--*-- Size = 114376MB
--*-- Stripe Size
--*-- Accept
--*-- SPAN = NO
=====
--*-- RAID Level
--*-- RAID 0
--*-- RAID 1
=====
--*-- Choose RAID Level For This Logical Drive
=====
Use Cursor Keys To Navigate Between Items And Press Enter To Select An Option

```

8. When creating a RAID 1 set, select **Stripe Size** from the **Logical Drive** menu, then press <Enter>.
When creating a RAID 0 set, proceed to step 10.
9. Key-in the stripe size, then press <Enter>.

```

===== Logical Drive(s) Configured =====
===== LD   RAID   Size   #Stripes   StripeSz   Status =====
===== 0    1     114376MB 2         64 KB     ONLINE =====
--*-- Manage
--*-- Config
--*-- Initializ
--*-- Objects
--*-- Rebuild
--*-- Check C
=====
--*-- Enter Stripe Size In KB (4,8,16,32,64,128)? :64
=====
--*-- Logical Drive 0
--*-- RAID = 1
--*-- Size = 114376MB
--*-- Stripe Size
--*-- Accept
--*-- SPAN = NO
=====
--*-- Enter Stripe Size In KB (4,8,16,32,64,128)? :
=====
Use Cursor Keys To Navigate Between Items And Press Enter To Select An Option

```



For server systems, we recommend that you use a lower array block size. For multimedia computer systems used mainly for audio and video editing, we recommend a higher array block size for optimum performance.

Using New Configuration



When a RAID set is already existing, using the **New Configuration** command erases the existing RAID configuration data. If you do not want to delete the existing RAID set, use the **View/Add Configuration** command to view or create another RAID configuration.

To create a RAID set using the **New Configuration** option:

1. From the utility main menu, highlight **Configure**, then press <Enter>.
2. Use the arrow keys to select **New Configuration**, then press <Enter>.

```
----- Configuration Menu -----
----- Easy Configuration -----
-- Management -- New Configuration
-- Configure -- View/Add Configuration
-- Initialize -- Clear Configuration
-- Objects -- Select Boot Drive
-- Rebuild -----
-- Check Consistency -----

----- Defines Physical Arrays. An Array Will Automatically Become A logical drive -----
Use Cursor Keys To Navigate Between Items And Press Enter To Select An Option
```

3. Follow steps 3 to 7 of the previous section.
4. Select **Size** from the **Logical Drive** menu, then press <Enter>.
5. Key-in the desired logical drive size, then press <Enter>.

```
----- Logical Drive(s) Configured -----
----- LD RAID Size #Stripes StripeSz Status -----
----- 0 1 114376MB 2 64 KB ONLINE -----
-- Manage --
-- Configure --
-- Initialize --
-- Objects --
-- Rebuild --
-- Check C --

----- Enter Logical Drive Size (MB) :114376 -----

----- Logical Drive 0 -----
----- RAID = 1 -----
----- Size = 114376MB -----
----- Stripe Size -----
----- Accept -----
----- SPAN = NO -----

----- Enter Logical Drive Size (MB) -----

Use Cursor Keys To Navigate Between Items And Press Enter To Select An Option
```

6. Follow steps 8 to 13 of the previous section to create the RAID set.

5.2.2 Adding or viewing a RAID configuration

You can add a new RAID configuration or view an existing configuration using the **View/Add Configuration** command.

Adding a new RAID configuration

To add a new RAID configuration:

1. From the Management Menu, highlight **Configure**, then press <Enter>.
2. Use the arrow keys to select **View/Add Configuration**, then press <Enter>.

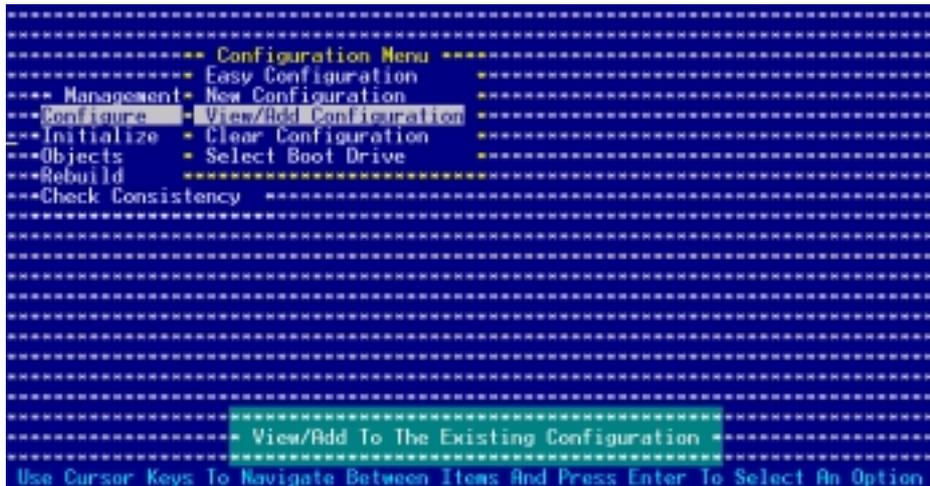

3. The **ARRAY SELECTION MENU** displays the available drives connected to the SATA ports. Select the drive(s) you want to include in the RAID set, then press <SpaceBar>. When selected, the drive indicator changes from **READY** to **ONLIN A[X]-[Y]**, where X is the array number, and Y is the drive number.

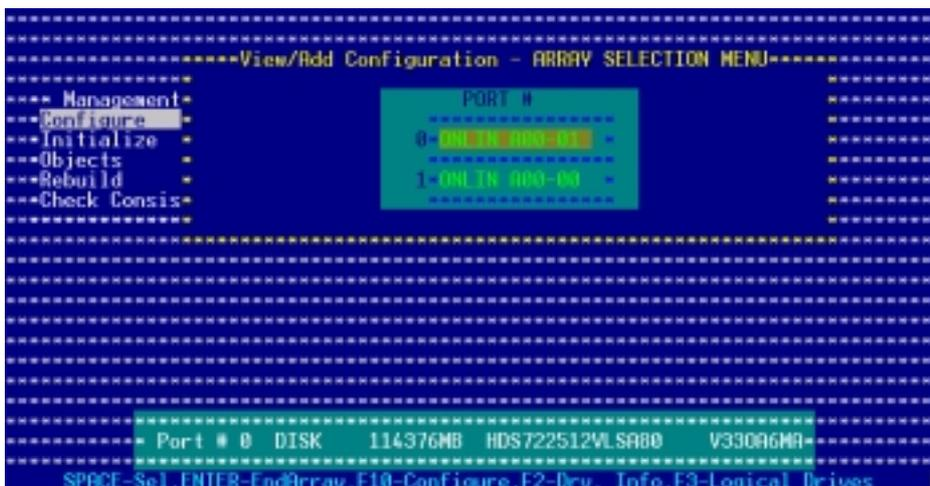

The information of the selected hard disk drive displays at the bottom of the screen.

4. Select all the drives required for the RAID set, then press <Enter>. The configurable array appears on screen.

```

=====View/Add Configuration - ARRAY SELECTION MENU=====
-----
-- Management --
-- Configure --
-- Initialize --
-- Objects --
-- Rebuild --
-- Check Consis --
-----
                                PORT #
                                0- ONLINE RAID-NO
                                1- ONLINE RAID-NO
-----
Port # 1 DISK 114376MB HD5722512VLSA88 V330A6MA
SPACE-Sel, ENTER-EndArray, F10-Configure, F2-Drv. Info, F3-Logical Drives

```

5. Press <F10>, select the configurable array, then press <SpaceBar>.

```

=====View/Add Configuration - ARRAY SELECTION MENU=====
-----Select Configurable Array(s)-----
-----
-- Management --
-- Configure --
-- Initialize --
-- Objects --
-- Rebuild --
-- Check Consis --
-----
                                0-0
                                1-1
-----
Cursor Keys, SPACE-(0e)Select F2-ChIdInfo F3-SlotInfo F10-Configure ESC-Quit

```

The logical drive information appears including a Logical Drive menu that allows you to change the logical drive parameters.

```

===== Logical Drive(s) Configured =====
-----
LD RAID Size #Stripes StripeSz Status
-----
0 1 114376MB 2 64 KB ONLINE
-----
-- Management --
-- Configure --
-- Initialize --
-- Objects --
-- Rebuild --
-- Check Con --
-----
-----Logical Drive 0-----
RAID = 1
Size = 114376MB
Stripe Size
Accept
SPAN = NO
-----
Choose RAID Level For This Logical Drive
-----
Use Cursor Keys To Navigate Between Items And Press Enter To Select An Option

```

6. Follow steps 6 to 7 of the **Creating a RAID set: Using Easy Configuration** section.
7. Select **Size** from the **Logical Drive** menu, then press <Enter>.
8. Key-in the desired logical drive size, then press <Enter>.

```

***** Logical Drive(s) Configured *****
***** LD   RAID   Size   #Stripes   StripeSz   Status *****
***** 0     1     114376MB   2         64 KB     ONLINE *****
-- Manage --
-- Confirmed --
-- Initialize --
-- Objects --
-- Rebuild --
-- Check C --
*****
***** Enter Logical Drive Size (MB) :114376 *****
*****
***** Logical Drive 0 *****
***** RAID = 1 *****
***** Size = 114376MB *****
***** Stripe Size *****
***** Accept *****
***** SPAN = NO *****
*****
***** Enter Logical Drive Size (MB) : *****
*****
Use Cursor Keys To Navigate Between Items And Press Enter To Select An Option

```

9. Follow steps 8 to 13 of the **Creating a RAID set: Using Easy Configuration** section to add the new RAID configuration.

- When prompted, press the <SpaceBar> to select **Yes** from the **Initialize?** dialog box, then press <Enter>. You may also press <F10> to initialize the drive without confirmation.

```
-----
----- Logical Drive(s) Configured -----
Management Menu ** LD   RAID   Size   #Stripes  StripeSz  Status
-----
--Configure
--Initialize      0     1     114376MB 2         64 KB    ONLINE
--Objects
--Rebuild
--Check Consistency
-----
--Initialize ?--
-- Yes
-- No
-----
--Logical Drives--
-----
----- Initialize Will Destroy Data On Selected Logical Drive(s). -----
SPACE-(De)Select, F10-Initialize
```



Initializing a logical drive(s) erases all data on the drive.

- A progress bar appears on screen. If desired, press <Esc> to abort initialization.

```
-----
----- Logical Drive(s) Configured -----
Management Menu ** LD   RAID   Size   #Stripes  StripeSz  Status
-----
--Configure
--Initialize      * Initialize Logical Drives In Progress *-----ONLINE
--Objects
--Rebuild      Array Initialization Under Progress. Press ESC to ABORT
--Check C
-----
-----
----- 16 % Completed -----
-----
--Logica
-----
-----
SPACE-(De)Select, F10-Initialize
```

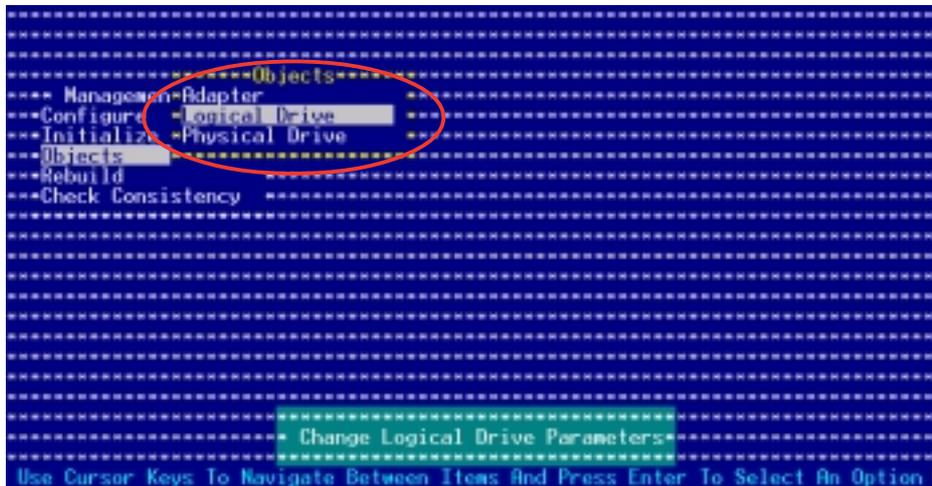

2. Select **Logical Drive** from the **Objects** sub-menu, then press <Enter>.

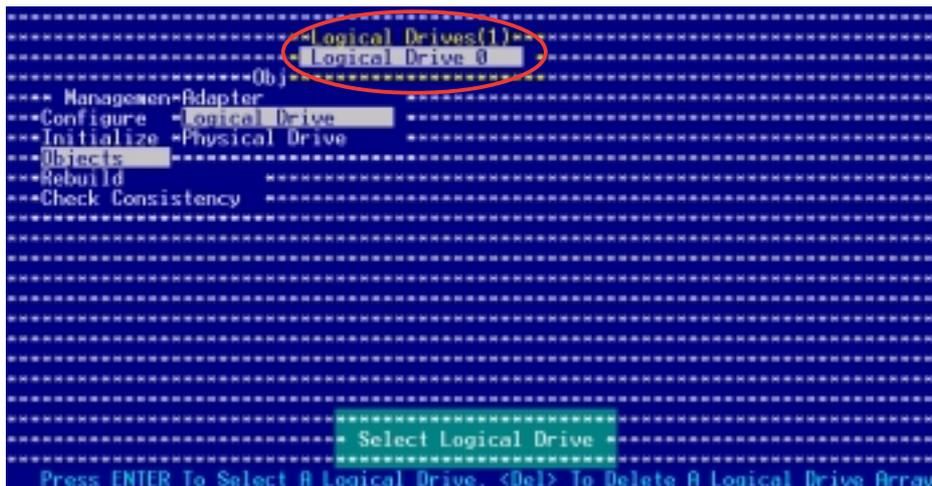

3. Select the logical drive to initialize from the **Logical Drives** sub-menu, then press <Enter>.

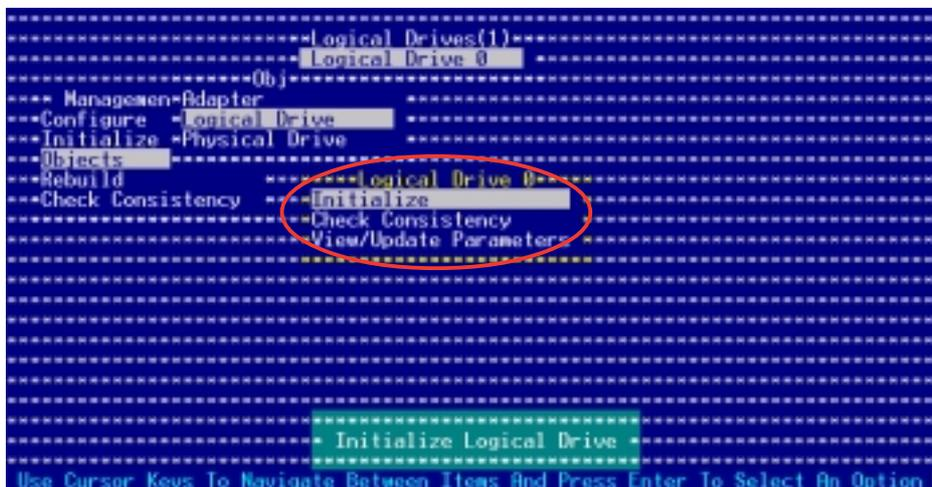

4. Select Initialize from the pop-up menu, then press <Enter> to start initialization.



- When prompted, press the <SpaceBar> to select **Yes** from the **Initialize?** dialog box, then press <Enter>. You may also press <F10> to initialize the drive without confirmation.

```
.....Logical Drives(1).....
.....Logical Drive 0.....
.....Obj.....
.....Management=Adapter.....
.....Configure =Logical Drive.....
.....Initialize =Physical Drive.....
.....Objects.....
.....Rebuild.....
.....Check Consistency.....
.....Initialize.....
.....Check Consistency.....
.....View/Update.....
.....Yes.....
.....No.....
.....
.....Initialize Will Destroy Data On Selected Logical Drive(s).
Use Cursor Keys To Navigate Between Items And Press Enter To Select An Option
```

- A progress bar appears on screen. If desired, press <Esc> to abort initialization.

```
.....Logical Drives(1).....
.....Logical Drive 0.....
.....Obj.....
.....Management=Adapter.....
.....Configure =Logical Drive.....
.....Initial.....
.....Initialize Logical Drives In Progress.....
.....Objects.....
.....Rebuild Array Initialization Under Progress. Press ESC to ABORT.....
.....Check C.....
.....
..... / 23 % Completed.....
.....
Use Cursor Keys To Navigate Between Items And Press Enter To Select An Option
```

- When initialization is completed, press <Esc>.

```
.....Logical Drives(1).....
.....Logical Drive 0.....
.....Obj.....
.....Management=Adapter.....
.....Configure =Logical Drive.....
.....Initial.....
.....Initialize Logical Drives In Progress.....
.....Objects.....
.....Rebuild Array Initialization Complete !! Press ESC.....
.....Check C.....
.....
..... | 100% Completed.....
.....
Use Cursor Keys To Navigate Between Items And Press Enter To Select An Option
```

5.2.4 Rebuilding failed drives

You can manually rebuild failed hard disk drives using the **Rebuild** command in the Management Menu.

To rebuild a failed hard disk drive:

1. From the Management Menu, highlight **Rebuild**, then press <Enter>.



2. The **PHYSICAL DRIVES SELECTION MENU** displays the available drives connected to the SATA ports. Select the drive you want to rebuild, then press <SpaceBar>.

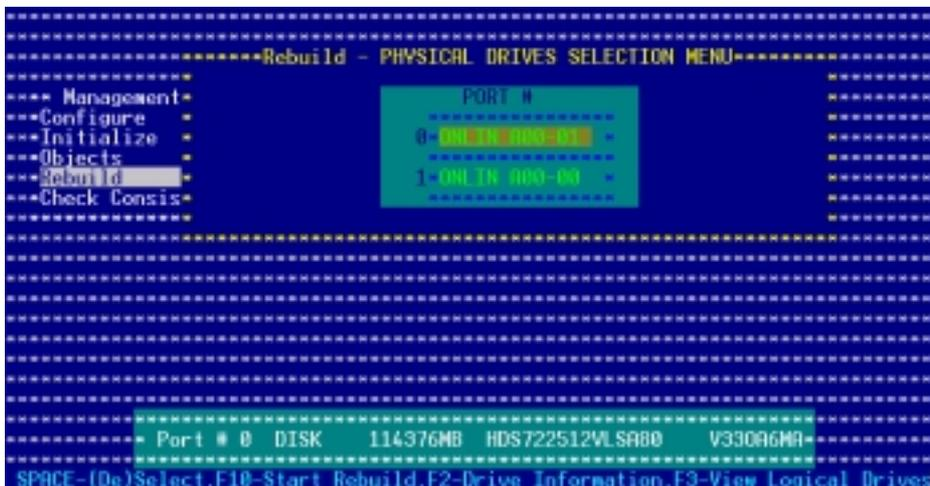

3. After selecting the drive to rebuild, press <F10>. The indicator for the selected drive now shows **RBLD**.

```
-----Rebuild - PHYSICAL DRIVES SELECTION MENU-----
Management
Configure
Initialize
Objects
Rebuild
Check Consis

PORT #
0-RBLD-RA00-01
1-ONLN-RA00-00

Port # 0 DISK 114376MB HDS722512VLSA80 V330A6MA
SPACE-[De]Select,F10-Start Rebuild,F2-Drive Information,F3-View Logical Drives
```

4. When prompted, press <Y> to to rebuild the drive.

```
-----Rebuild - PHYSICAL DRIVES SELECTION MENU-----
Management
Configure
Initialize
Objects

Rebuilding Drive Will Take Few Minutes. Start Rebuilding Drive (Y/N)?

Port # 0 DISK 114376MB HDS722512VLSA80 V330A6MA
SPACE-[De]Select,F10-Start Rebuild,F2-Drive Information,F3-View Logical Drives
```

5. When rebuild is complete, press any key to continue.

5.2.5 Checking the drives for data consistency

You can check and verify the accuracy of data redundancy in the selected logical drive. The utility can automatically detect and/or detect and correct any differences in data redundancy depending on the selected option in the **Objects > Adapter** menu.



The Check Consistency command is available only for logical drives included in a RAID 1 set.

Using the Check Consistency

To check data consistency using the **Check Consistency** command:

1. From the Management Menu, select **Check Consistency**, then press <Enter>.

```
----- Management Menu -----
-->Configure
-->Initialize
-->Objects
-->Rebuild
-->Check Consistency
-----

----- Check Consistency Of Logical Drive(s) -----
Use Cursor Keys To Navigate Between Items And Press Enter To Select An Option
```

2. The screen displays the available RAID set(s) and prompts you to select the logical drive to check. Use the arrow keys to select the logical drive from the **Logical Drive** selection, then press <Enter>.

```
----- Logical Drive(s) Configured -----
Management Menu -- LD  RAID  Size  #Stripes  StripeSz  Status
-->Configure      =  0    1   114376MB  2         64 KB   ONLINE
-->Initialize
-->Objects
-->Rebuild
-->Check Consistency
-----

----- Logical Drives -----
-->Logical Drive
-----

----- Select Logical Drive -----
SPACE-(Dc)Select, F10-Check Consistency
```

Using the Objects command

To check data consistency using the **Objects** command:

1. From the Management Menu, select **Objects**, then select **Logical Drive** from the menu.
2. Use the arrow keys to select the logical drive you want to check, then press <Enter>.
3. Select **Check Consistency** from the pop-up menu, then press <Enter>.
4. When prompted, press <Y> to to check the drive.
5. When checking is complete, press any key to continue.

5.2.6 Deleting a RAID configuration

To delete a RAID configuration:

1. From the Management Menu, select **Configure > Clear Configuration**, then press <Enter>.



```
----- Configuration Menu -----
----- Easy Configuration -----
-- Management -- New Configuration
-- Configure -- View/Add Configuration
-- Initialize -- Clear Configuration
-- Objects -- Select Boot Drive
-- Rebuild
-- Check Consistency
-----

----- Clear Existing Configuration -----

Use Cursor Keys To Navigate Between Items And Press Enter To Select An Option
```

2. When prompted, press the <SpaceBar> to select **Yes** from the **Clear Configuration?** dialog box, then press <Enter>.



```
----- Configuration Menu -----
----- Easy Configuration -----
-- Management -- New Configuration
-- Configure -- View/Add Configuration
-- Initialize -- Clear Configuration?
-- Objects -- Select
-- Rebuild
-- Check Consistency
-----

----- Clear Existing Configuration -----

Use Cursor Keys To Navigate Between Items And Press Enter To Select An Option
```

The utility clears the current array.

3. Press any key to continue.

5.2.7 Selecting the boot drive from a RAID set

You must have created a new RAID configuration before you can select the boot drive from a RAID set. Refer to the **Creating a RAID set: Using New Configuration** section for details.

To select the boot drive from a RAID set:

1. From the Management Menu, select **Configure > Select Boot Drive**, then press <Enter>.



2. When prompted, press the <SpaceBar> to select the bootable logical drive from the list, then press <Enter>.

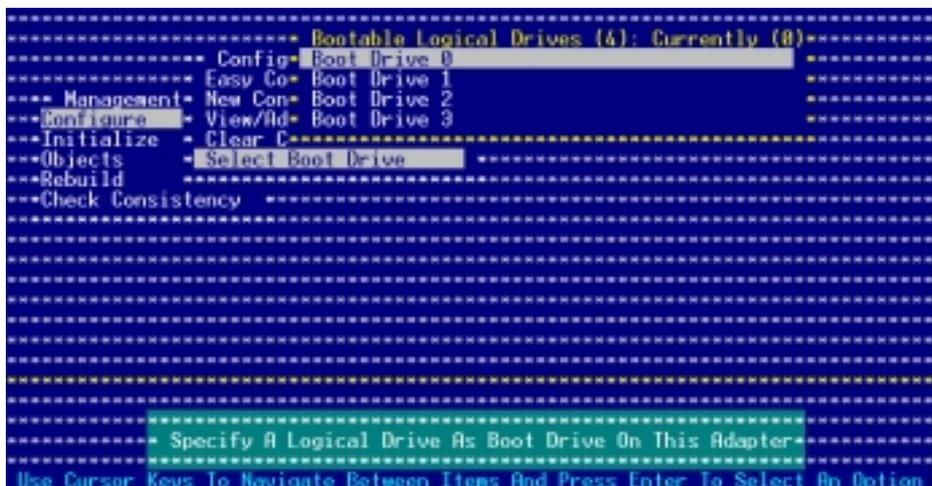

3. The logical drive is selected as boot drive. Press any key to continue.

5.2.8 Enabling the WriteCache

You may enable the RAID controller's **WriteCache** option to improve the data transmission performance.



When you enable WriteCache, you may lose data when a power interruption occurs while transmitting or exchanging data among the drives.

To enable WriteCache:

1. From the Management Menu, select **Objects > Adapter**, then press <Enter> to display the adapter properties.
2. Select **WriteCache**, then press <Enter> to turn the option **On** (enabled).

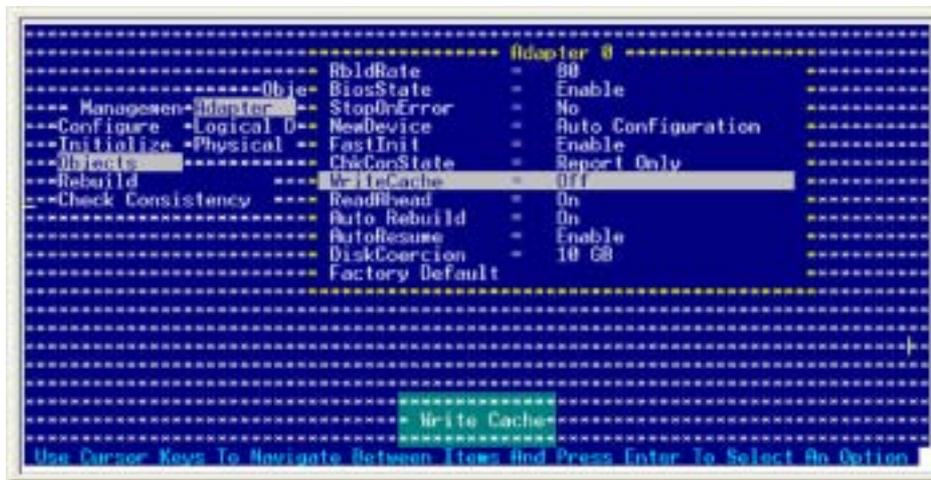

3. When finished, press any key to continue.

5.3 Global Array Manager

You may also create a RAID set(s) in Windows® operating environment using the Global Array Manager (GAM) application. The GAM application is available from the motherboard support CD.



Refer to the GAM user guide in the motherboard support CD for details.

5.4.1 Configuring the SCSI controller

You need to configure the SCSI controller before creating a RAID set. After selecting the SCSI channel to use, the utility prompts you to select from the available options. Use the arrow keys to select **Configure/View SCSI Controller Settings**, then press <Enter>.



5.4.2 Enabling the HostRAID controller

To enable the Adaptec HostRAID controller:

1. Use the arrow keys to select the **HostRAID** item in the Configuration section.
2. Press <Enter> to set the item to **Enabled**.

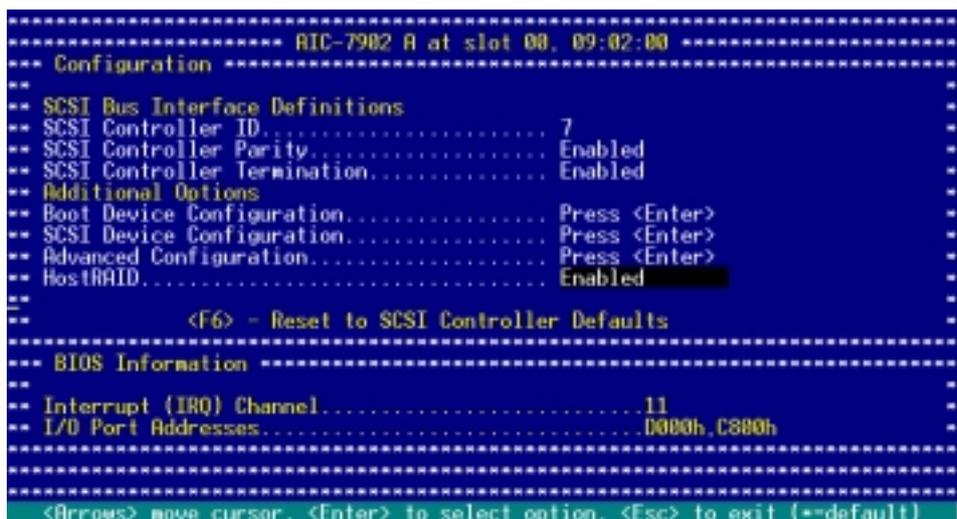

3. Press <Esc> to exit.
4. When the utility prompts you to save the changes, select **Yes**, then press <Enter>.



The screen returns to the options menu.

```
----- AIC-7902 A at slot 00, 09:02:00 -----
Would you like to configure the SCSI controller, configure
the HostRAID settings, or run the SCSI Disk Utilities?
Select the option and press <Enter>.

***** Options *****
** Configure/View SCSI Controller Settings **
** Configure/View HostRAID Settings **
** SCSI Disk Utilities **

<Arrows> move cursor, <Enter> to select option, <Esc> to exit (*-default)
```

5.4.3 Creating a RAID 0 set (Stripe)

To create a RAID 0 set for Performance:

1. After enabling the HostRAID, the utility returns to the initial menu. Use the arrow keys to select **Configure/View HostRAID Settings**, then press <Enter>.

```
----- AIC-7902 A at slot 00, 09:02:00 -----
Would you like to configure the SCSI controller, configure
the HostRAID settings, or run the SCSI Disk Utilities?
Select the option and press <Enter>.

***** Options *****
** Configure/View SCSI Controller Settings **
** Configure/View HostRAID Settings **
** SCSI Disk Utilities **

<Arrows> move cursor, <Enter> to select option, <Esc> to exit (*-default)
```

- The utility displays the installed SCSI hard disk drives status and menu options. When available, the HDD status shows **Free**. Press **<C>**.

```
***** AIC-7902 A at slot 00, 09:02:00 *****
Create, Spare, Delete, Rebuild, Verify, Bootable
-----
ID  Type      Vendor  Product      Size  Status
-----
0   Hard Drive SEAGATE ST318432LC   18GB Free
1   Hard Drive SEAGATE ST318432LC   18GB Free
2   Hard Drive SEAGATE ST318432LC   18GB Free
-----
<Arrows> move cursor, <Enter> accept option, <Esc> exit
```



The utility does not display an installed SCSI HDD(s) with an existing RAID configuration or is part of an existing RAID set. Use the **SCSI Disk Utilities** to reformat the HDD(s), or use the previous RAID card to clear the RAID configuration on the HDD(s).

- Select **RAID-0 (High Performance, No Fault Tolerance)** from the **Select RAID Type** menu, then press **<Enter>**.

```
***** AIC-7902 A at slot 00, 09:02:00 *****
Create RAID
-----
ID  Vendor  Product      Size
-----
0   SEAGATE ST318432LC   18GB
1   SEAGATE ST318432LC   18GB
2   SEAGATE ST318432LC   18GB
-----
***** Select RAID Type *****
* RAID-0 (High Performance, No Fault Tolerance)
* RAID-1 (Fault Tolerance)
* RAID-10 (Fault Tolerance, High Performance)
-----
***** Striping Requirements *****
Min 2 drives, Max 4 drives.
-----
<Arrows> move cursor, <Enter> accept option, <Esc> exit
```



Refer to the **Striping Requirements** note at the bottom of the screen to determine the number of hard disk drives required for the selected RAID type.

5.4.4 Creating a RAID 1 set (Mirror)

To create a RAID 1 set for Fault Tolerance:

1. Follow steps 1 to 2 of the **Creating a RAID 0 set** section.
2. Select **RAID-1 (Fault Tolerance)** from the **Select RAID Type** menu, then press <Enter>.

```
***** AIC-7902 A at slot 00, 09:02:00 *****
*** Create RAID ****
**
**          ID  Vendor  Product          Size
**          ---  ---    ---              ---
**          0  SEAGATE ST318432LC      18GB
**          1  SEAGATE ST318432LC      18GB
**          2  SEAGATE ST318432LC      18GB
**
**          ***** Select RAID Type *****
**          RAID-0 (High Performance, No Fault Tolerance)
**          RAID-1 (Fault Tolerance)
**          RAID-10 (Fault Tolerance, High Performance)
**
**          ***** Mirroring Requirements *****
**          Min 2 drives, Max 2 drives.
**
**
**          <Arrows> move cursor, <Enter> accept option, <Esc> exit
```



Refer to the **Mirroring Requirements** note at the bottom of the screen to determine the number of hard disk drives required for the selected RAID type.

3. Use the arrow keys to select a RAID set member, then press <SpaceBar> to mark. An X mark appears after the selected HDD.
4. Follow step 3 to select the other members of the RAID set, then press <Enter> when finished.

```
***** AIC-7902 A at slot 00, 09:02:00 *****
*** RAID-1: Select RAID members ****
**
**          ID  Vendor  Product          Size
**          ---  ---    ---              ---
**          0  SEAGATE ST318432LC      18GB  X
**          1  SEAGATE ST318432LC      18GB  X
**          2  SEAGATE ST318432LC      18GB
**
**
**          <Space> select drives
**          <Arrows> move cursor, <Enter> accept option, <Esc> exit
```

6. Select **Create new RAID-1** from the RAID-1 Build Option menu, then press <Enter>. Refer to the options description below.

```
***** RAID-1 Build Option *****
- Create new RAID-1 -
- Copy from ( 0) to ( 1) -
- Copy from ( 1) to ( 0) -
*****
```

- **Create a New RAID-1** - The default option. Select this option when creating a new RAID 1 set.
- **Copy from (0) to (1)** - Select this option when you want to copy the source drive contents to a target drive, provided that the source is equal to or smaller than the target drive.
- **Copy from (1) to (0)** - Select this option when you want to copy the source drive contents to a target drive, provided that the source is larger than the target drive.

7. When prompted, use the keyboard to assign a name for the RAID 1 set, then press <Enter>.

```
***** Assign RAID Name *****
* Enter 1 to 15 alphabetic or numeric *
* characters. Press <Enter> when finished. *
* ICH5R *
*****
```

8. If you want to make the array bootable, select **Yes** from the menu, then press <Enter>.

```
*****
* Do you want to make *
* this array as bootable? *
* *
* Yes *
* No *
*****
```

9. When prompted to create the RAID 1 set, select <Yes>, then press <Enter>.

```
*** Create Array? ***
* Yes *
* No *
*****
```



The utility erases all data from the selected hard disk drives. Make sure to backup all important data before creating a RAID set.

10. When a confirmation dialogue box appears, select <Yes>, then press <Enter>.

```
*** Are you sure? ***
* Yes *
* No *
*****
```

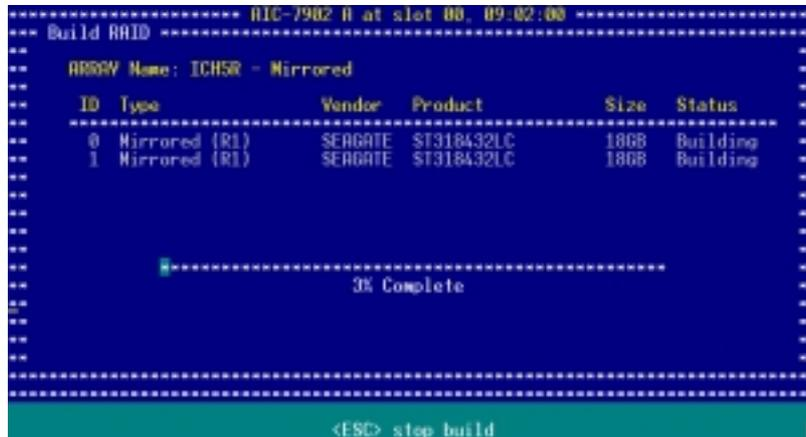

- The utility builds the RAID 1 set and displays a progress bar at the center of the screen. Press <Esc> if you want to stop the building process.



A **Build Complete** message appears to indicate that you have successfully created the RAID 1 set.

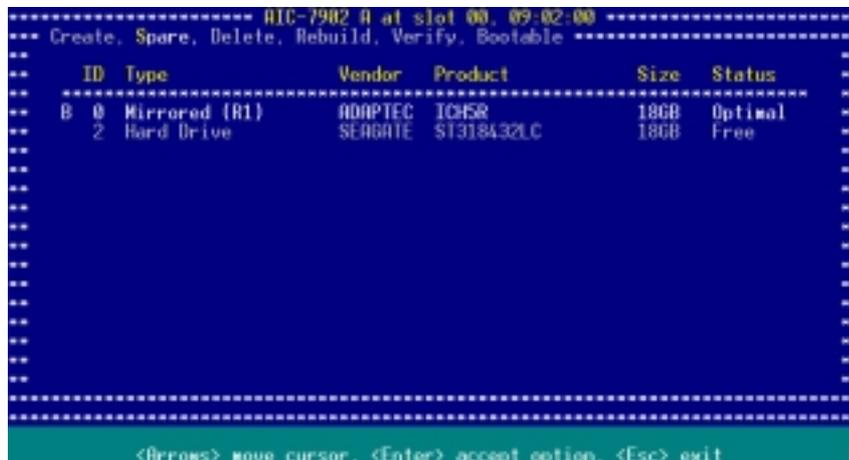

- The screen displays the information on the created RAID set. Press <Esc> to exit the utility.



5.4.5 Creating a RAID 10 set (Stripe+Mirror)

To create a RAID 10 set for Fault Tolerance and Performance:

1. After enabling the HostRAID, the utility returns to the initial menu. Use the arrow keys to select **Configure/View HostRAID Settings**, then press <Enter>.

```
----- AIC-7902 A at slot 00, 09:02:00 -----
Would you like to configure the SCSI controller, configure
the HostRAID settings, or run the SCSI Disk Utilities?
Select the option and press <Enter>.

----- Options -----
Configure/View SCSI Controller Settings
Configure/View HostRAID Settings
SCSI Disk Utilities

<Arrows> move cursor, <Enter> to select option, <Esc> to exit (*=-default)
```

2. The utility displays the SCSI hard disk drives installed in your computer and the menu options. Press <C>.

```
----- AIC-7902 A at slot 00, 09:02:00 -----
Create, Spare, Delete, Rebuild, Verify, Bootable
-----
ID  Type          Vendor  Product      Size  Status
-----
4   Hard Drive    FUJITSU MAT3073NC  74GB  Free
5   Hard Drive    FUJITSU MAT3073NC  74GB  Free
6   Hard Drive    FUJITSU MAT3073NC  74GB  Free
8   Hard Drive    FUJITSU MAT3073NC  74GB  Free
9   Hard Drive    FUJITSU MAT3073NC  74GB  Free
10  Hard Drive    FUJITSU MAT3073NC  74GB  Free

<Arrows> move cursor, <Enter> accept option, <Esc> exit
```

6. Select the stripe size from the menu, then press <Enter>.

```
*** Select stripe size ***
* 16-KB *
* 32-KB *
* 64-KB *
*****
```



For server systems, we recommend that you use a lower array block size. For multimedia computer systems used mainly for audio and video editing, we recommend a higher array block size for optimum performance.

7. When prompted, use the keyboard to assign a name for the RAID 10 set, then press <Enter>.

```
***** Assign RAID Name *****
* Enter 1 to 15 alphabetic or numeric *
* characters. Press <Enter> when finished. *
* *
* 7902 *
* *
*****
```

8. If you want to make the array bootable, select **Yes** from the menu, then press <Enter>.

```
*****
* Do you want to make *
* this array as bootable? *
* *
* Yes *
* No *
*****
```

9. When prompted to create the RAID 10 set, select <Yes>, then press <Enter>.

```
*** Create Array? ***
* Yes *
* No *
*****
```



The utility erases all data from the selected hard disk drives. Make sure to backup all important data before creating a RAID set.

A **Build Complete** message appears to indicate that you have successfully created the RAID 10 set.

```
*****
* Build Completed. *
*****
```



5.4.6 Adding a spare drive to a RAID 10 set

To add a spare drive to a RAID 10 set:

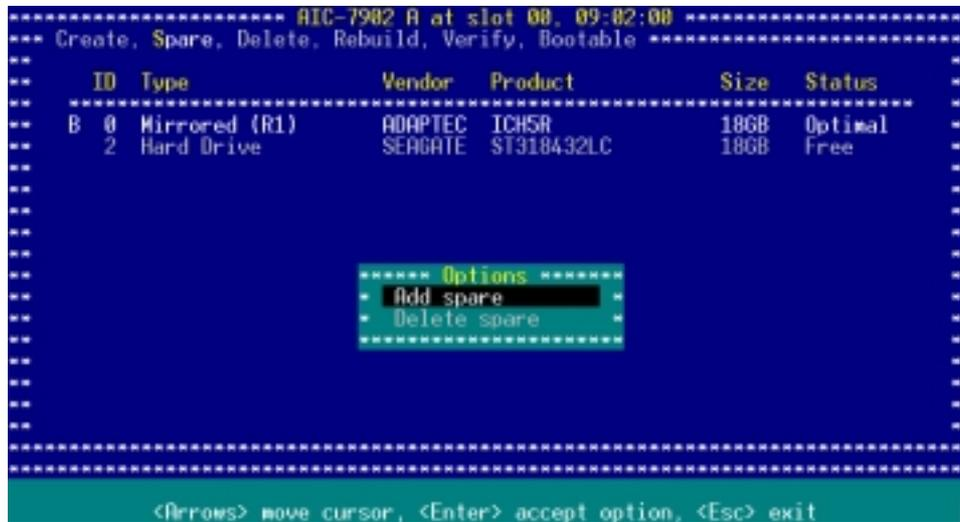
1. Press <S> from the **Configure/View Host RAID Settings** menu.
2. Select **Add Spare** from the Options menu, then press <Enter>.

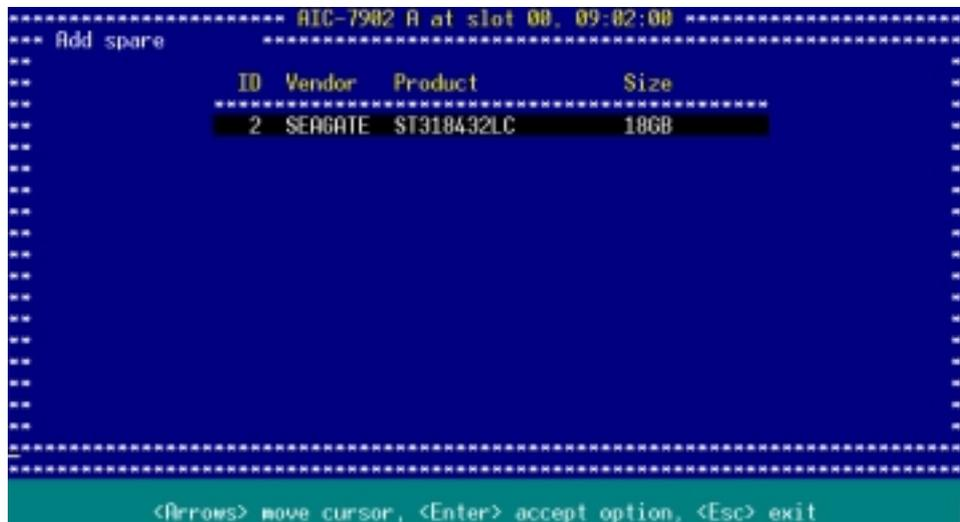

3. Use the arrow keys to select the spare drive from the list, then press <Enter>.



4. When a confirmation dialogue box appears, select <Yes>, then press <Enter>.



- The screen displays the available spare drive(s). Use the arrow keys to select the spare drive you want to delete, then press <Enter>.

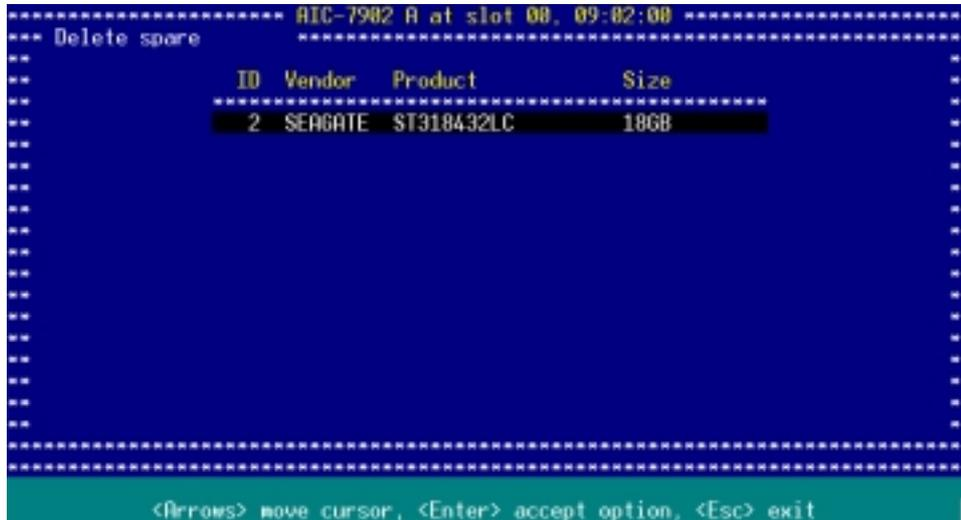

- When a confirmation dialogue box appears, select <Yes>, then press <Enter> to delete the spare drive.
- Press <ESC> to exit the utility.



2. Select the RAID set you want to make bootable, then press <Enter>.

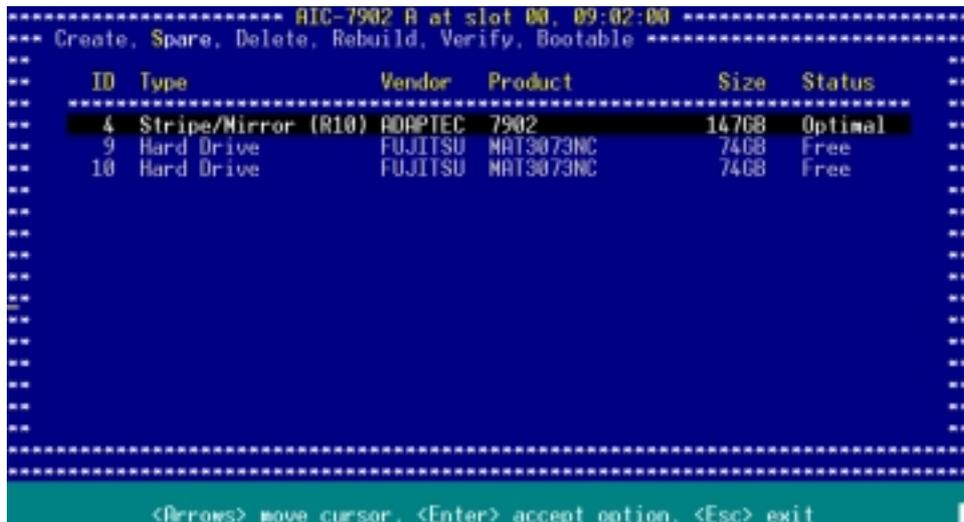

3. Press when the RAID set information displays on screen.

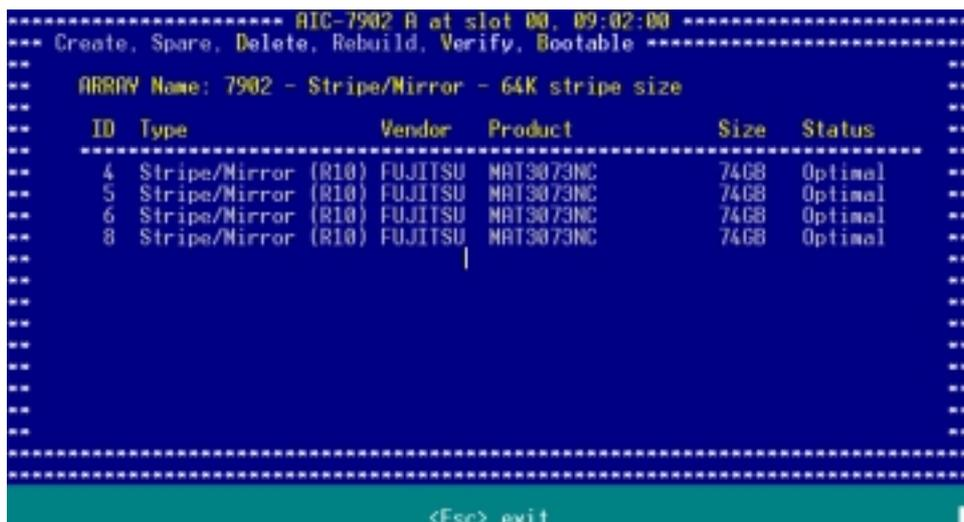

4. When prompted, select **Mark bootable**, then press <Enter>.



The letter "B" appears before a bootable RAID set for easy identification.



5.5 Adaptec® RAID Configuration Utility (NCLV-D2/SATA model only)

The Adaptec RAID Configuration Utility allows you to create RAID 0, RAID 1, and RAID 10 set(s) from SATA hard disk drives connected to the SATA connectors supported by the Adaptec® SATA RAID controller.

To enter the Adaptec RAID Configuration Utility:

1. Turn on the system after installing all the SATA hard disk drives.
2. During POST, the Adaptec HostRAID™ technology automatically detects the installed SATA hard disk drives and displays any existing RAID set(s). Press <Ctrl> + <A> to enter the utility.

```
Adaptec Embedded SATA HostRAID BIOS V2.2-1 1237
(c) 1998-2004 Adaptec, Inc. All Rights Reserved.

*** Press <Ctrl><A> for Adaptec RAID Configuration Utility! ***

Controller #00: HostRAID-ICH8 at PCI Bus:00, Dev:1F, Func:02
Loading Configuration...Done.
Port#00 ST380023AS      3.01      74.53 GB Healthy
Port#01 ST380023AS      3.01      74.53 GB Healthy

SATA JBOD- PORT-0 ST380023AS      74.53 GB
SATA JBOD- PORT-1 ST380023AS      74.53 GB

2 JBOD Device(s) Found.
```

3. Use the arrow keys to highlight an option.

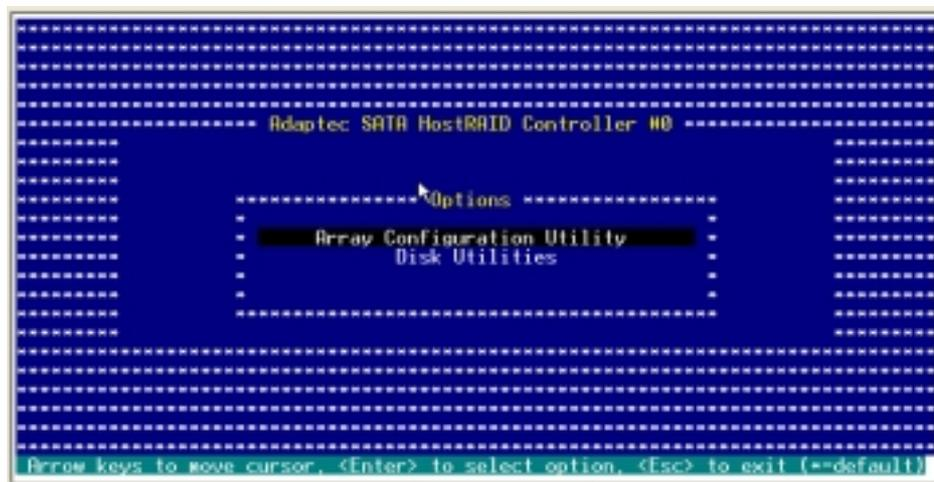

The **Array Configuration Utility** menu lets you create and manage RAID sets. The **Disk Utilities** allows you to format and/or check the consistency of the hard disk drives.

At the bottom of the screen is the legend box. The keys on the legend box allow you to navigate through the setup menu options or execute commands. The keys on the legend box vary according to the menu level.

5.5.1 Configuring the hard disk drive(s)

You must configure the drive(s) that you want to include in an array.

To configure the drive(s):

1. From the Adaptec RAID Configuration Utility initial menu, highlight **Array Configuration Utility**, then press <Enter>.
2. From the Main Menu, select **Configure Drives**, then press <Enter>.



3. Select the drive(s) that you want to configure, then press <Insert>. The selected drive appears in the **Selected Drives** section. Repeat the process to select other drives, then press <Enter>.

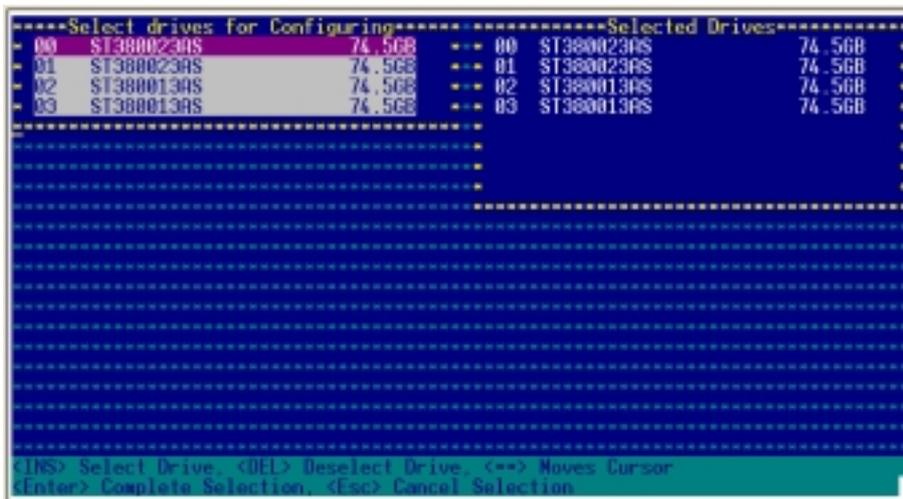

4. A warning message appears on screen. Press <Y> to configure the selected drives, or press <N> to abort.



5.5.2 Creating a RAID 0 set (Striped)

To create a RAID 0 set:

1. From the Adaptec RAID Configuration Utility initial menu, highlight **Array Configuration Utility**, then press <Enter>.
2. From the Main Menu, select **Create Array**, then press <Enter>.

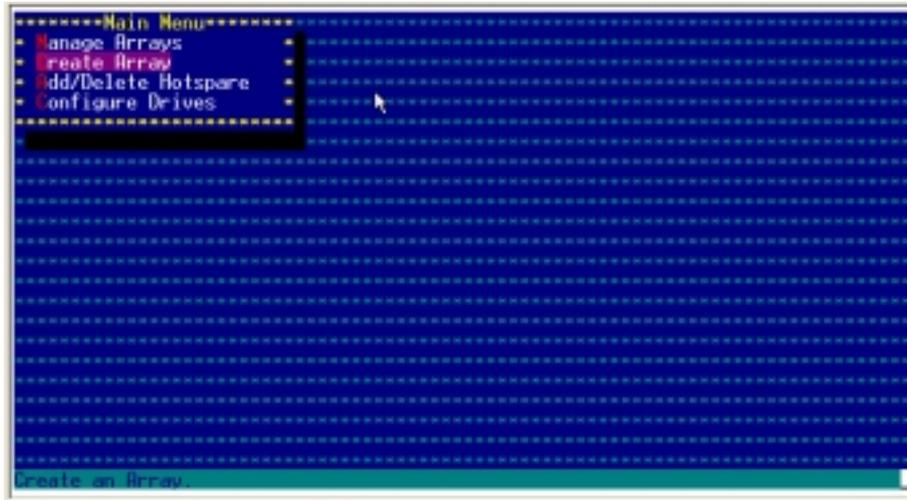

3. Select the first drive you want to add to the array, then press <Insert>. The selected drive appears in the **Selected Drives** section.

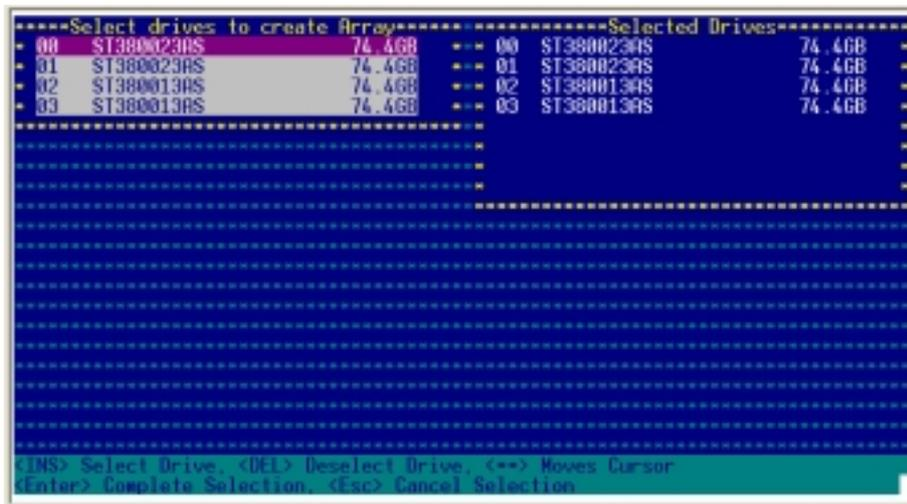

A RAID 0 set requires two identical hard disk drives.

4. When all the drives required for a RAID 0 set appear in the **Selected Drives** field, press <Enter>.

5. The utility displays the **Array Properties** menu. Select **Array Type > RAID 0 (Stripe)**, then press <Enter>.

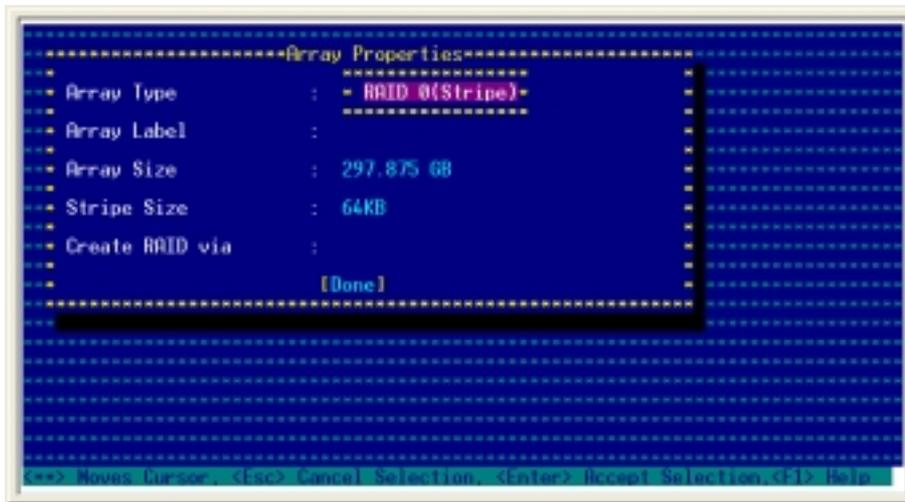

6. Move the cursor to the **Array Label** option, then type a name for the RAID 0 set. Press <Enter> when finished.

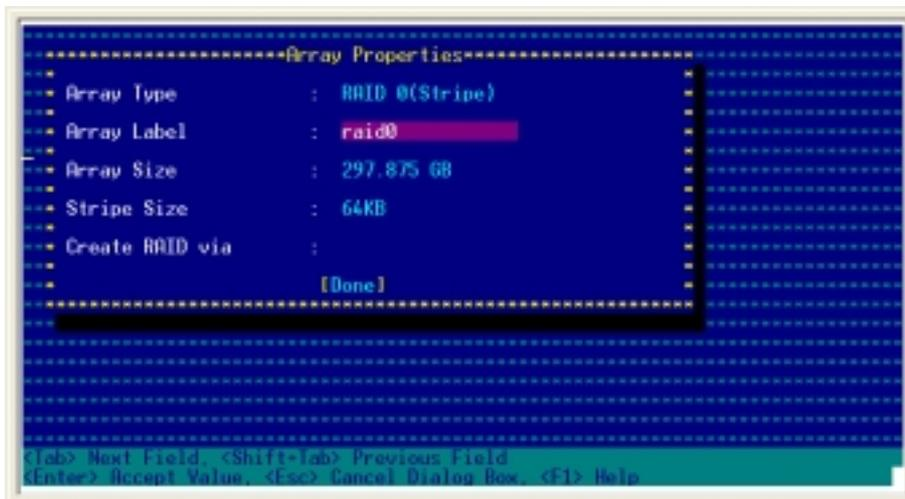

7. Move the cursor to the **Stripe Size** option, select **64KB** from the menu, then press <Enter> to select.

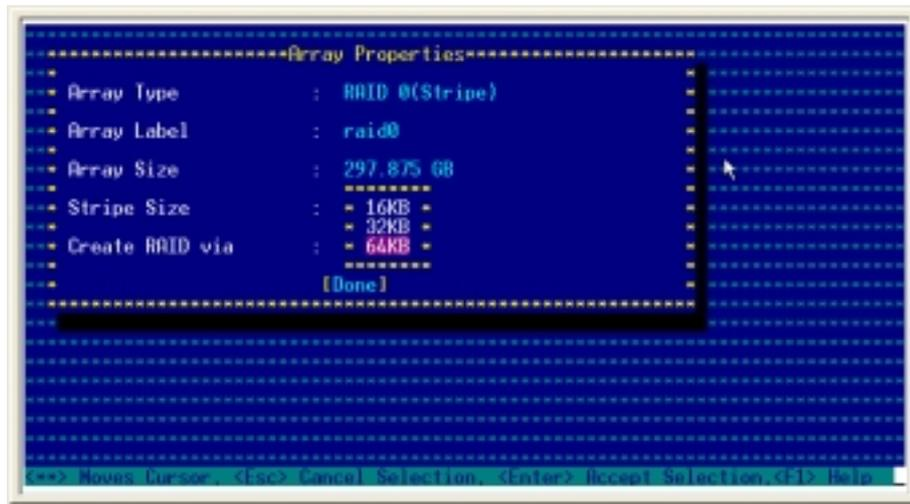

For server systems, we recommend that you use a lower array block size. For multimedia computer systems used mainly for audio and video editing, we recommend a higher array block size for optimum performance.

8. Move the cursor to the **Create RAID via** option, select **No Init** from the menu, then press <Enter> to select. **No Init** allows you to create a RAID set without initializing the drives.

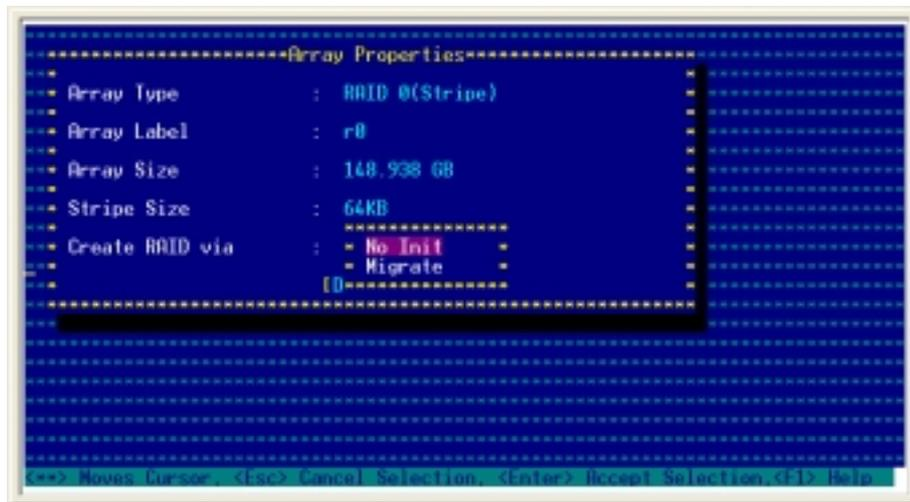

Select **Migrate** when one of the drives has data that you want to preserve. Refer to the section "Creating a RAID 0 set via Migrate" for details.

9. Move the cursor to **[Done]**, then press <Enter>.

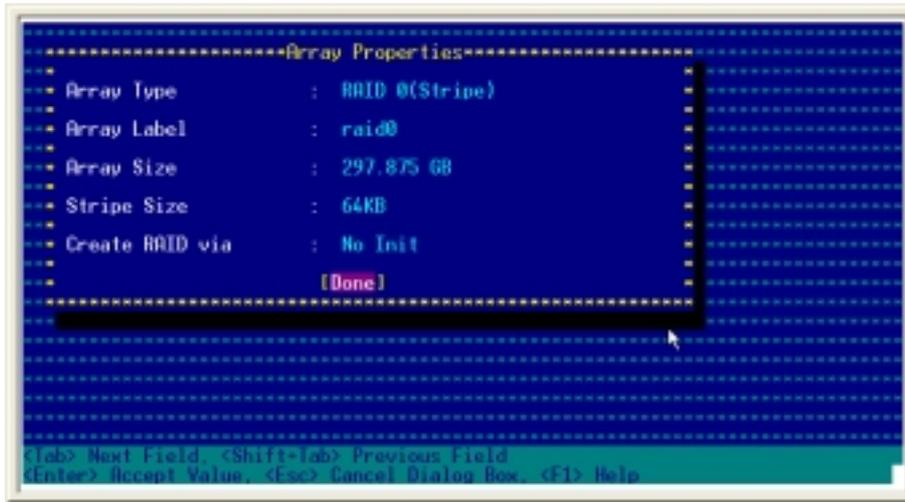

10. A message appears on screen when a member drive has a partition or boot block. Press <Y> to proceed, or press <N> to abort.



All partition table, boot block, and/or data in member drives will be erased when you select **Yes**.



11. After you have created the RAID 0 set, the utility main menu appears. Select **Manage Arrays** to display the array, then press <Enter> to view the array properties.

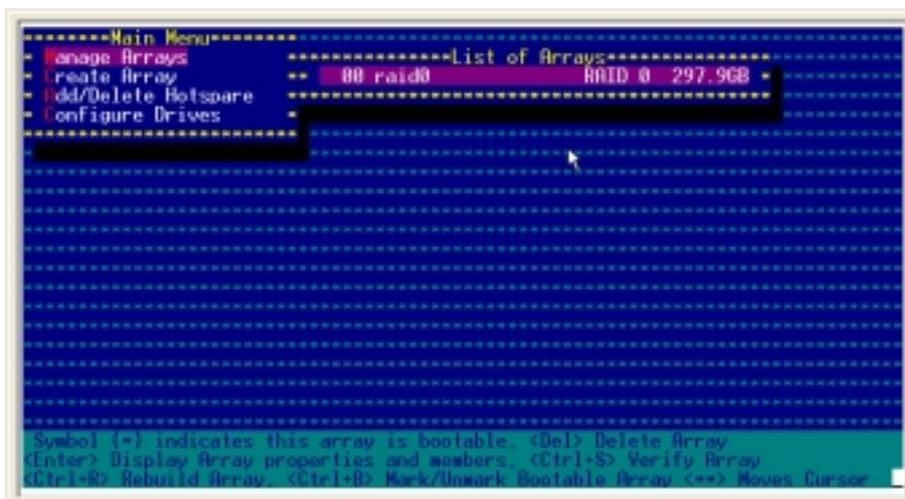

12. To exit the utility, press <Esc>, highlight **Yes**, then press <Enter>.



5.5.3 Creating a RAID 0 set via Migrate

When you are using one new and one used drive for a RAID 0 set, you can preserve the data on the used drive by creating the array via the **Migrate** option.

To create a RAID 0 set via **Migrate**:

1. Follow steps 1 to 7 of the previous section.
2. Move the cursor to the **Create RAID via** option, select **Migrate** from the menu, then press <Enter>.

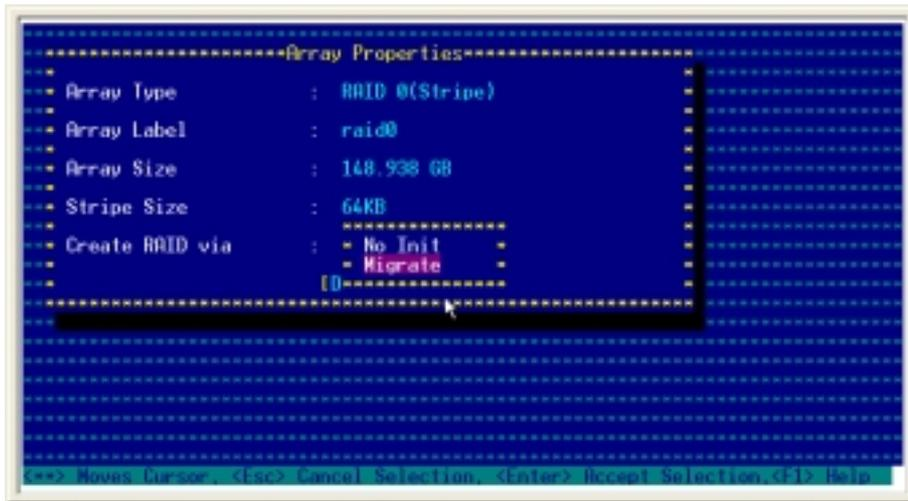

3. Move the cursor to **[Done]**, then press <Enter>.

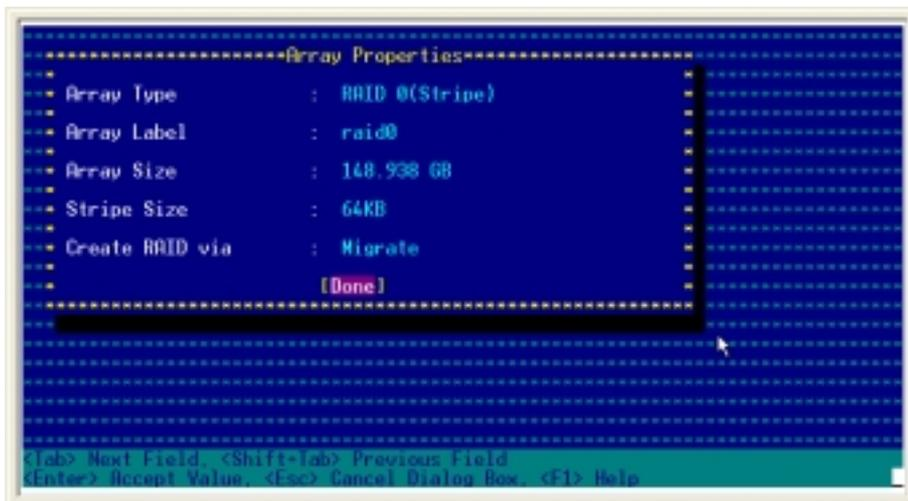

- When prompted, select the source drive, then press <Enter>.

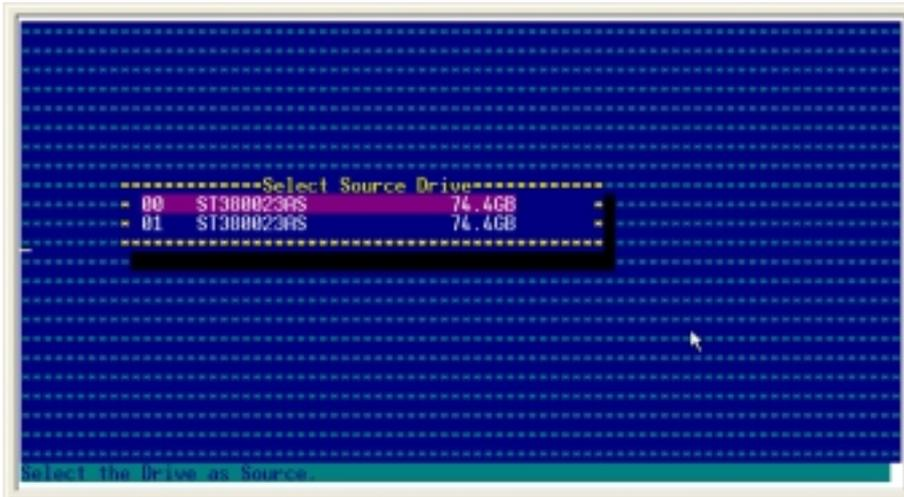

- A warning message appears on screen. Press <Y> to continue, or press <N> to abort.

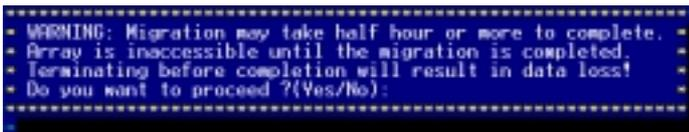

- The RAID 0 set is created via Migrate. Check the array status in the Array Properties window.

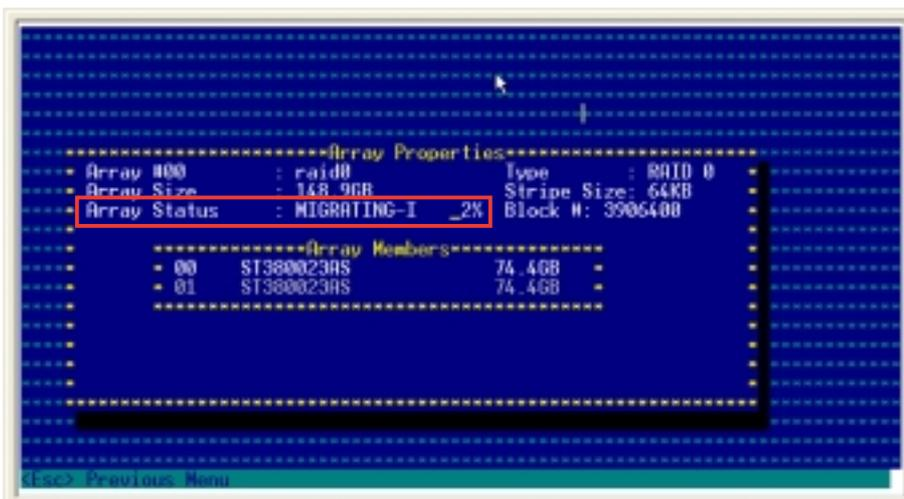

5.5.4 Creating a RAID 1 set (Mirrored)

To create a RAID 1 set:

1. Follow instructions 1 to 5 of the section “Creating a RAID 0 set (Stripe).”
2. From the **Array Properties** menu, select **Array Type > RAID 1 (Mirror)**, then press <Enter>.

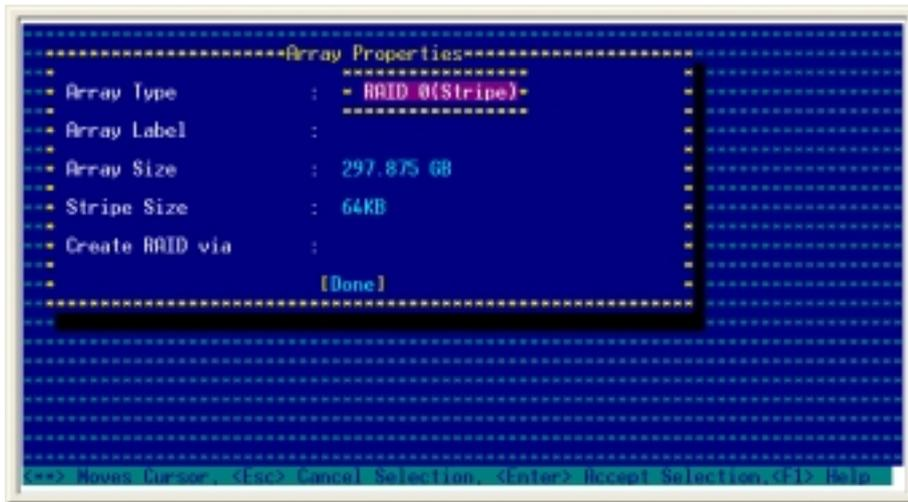

3. Move the cursor to the **Array Label** option, then type a name for the RAID 1 set. Press <Enter> when finished.

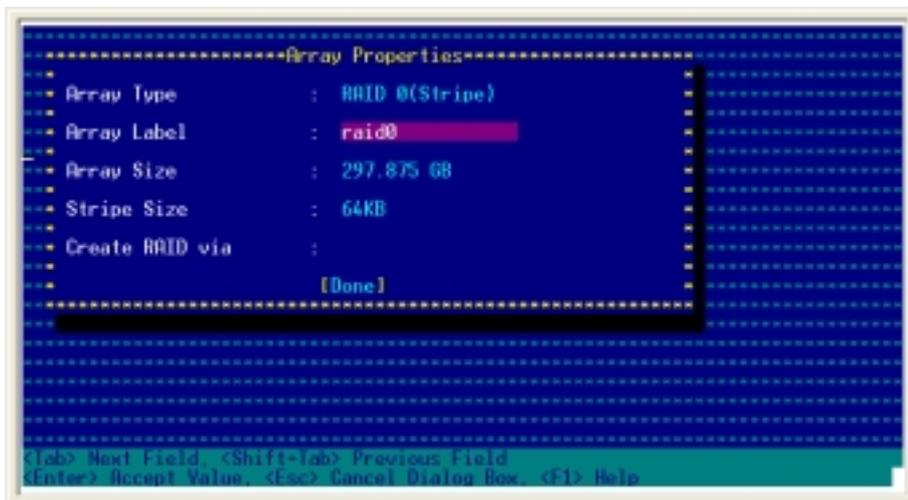

4. Move the cursor to the **Create RAID via** option, select **Quick Init** from the menu, then press <Enter>. Refer to the RAID creation options below.

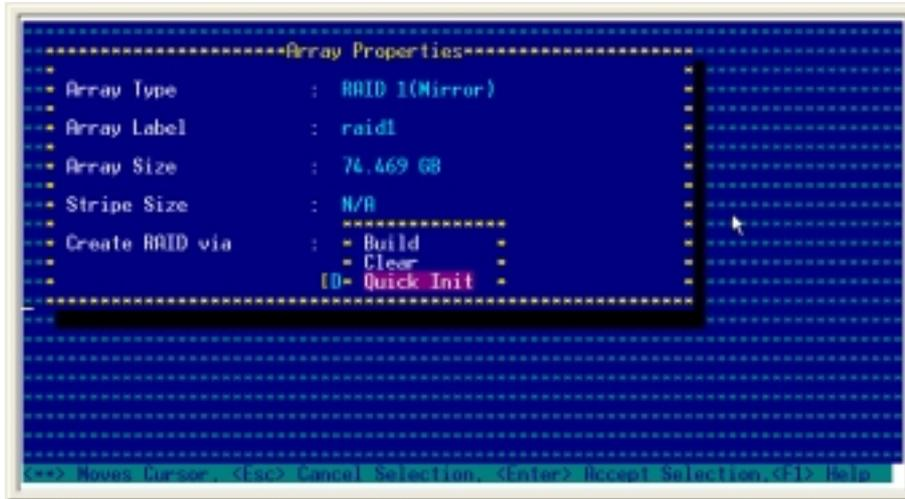

- Build** - Select this option when one of the drives has data that you want to preserve. When you create a RAID 1 set using **Build**, you are prompted to select the source drive. The contents of the source drive are preserved, but you lose all data on new drive(s).
- Clear** - Select this option to erase all existing data on new or old drives that you want to include in the RAID 1 set.
- Quick Init** - This is the fastest way to create a RAID 1 set. Use this option when using new drives.

5. When you have finished setting the array properties, move the cursor to **[Done]**, then press <Enter> to create the RAID 1 set.

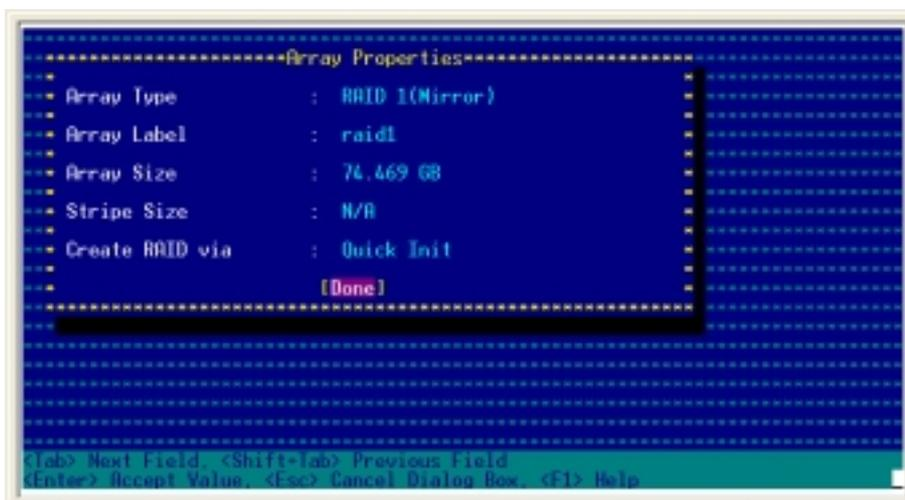

5.5.5 Deleting a RAID 0 set

To delete a RAID 0 set:

1. From the Adaptec RAID Configuration Utility initial menu, highlight **Array Configuration Utility**, then press <Enter>.
2. Select **Manage Array** from the Main Menu, then select the array that you want to delete. Press <Enter> when finished.

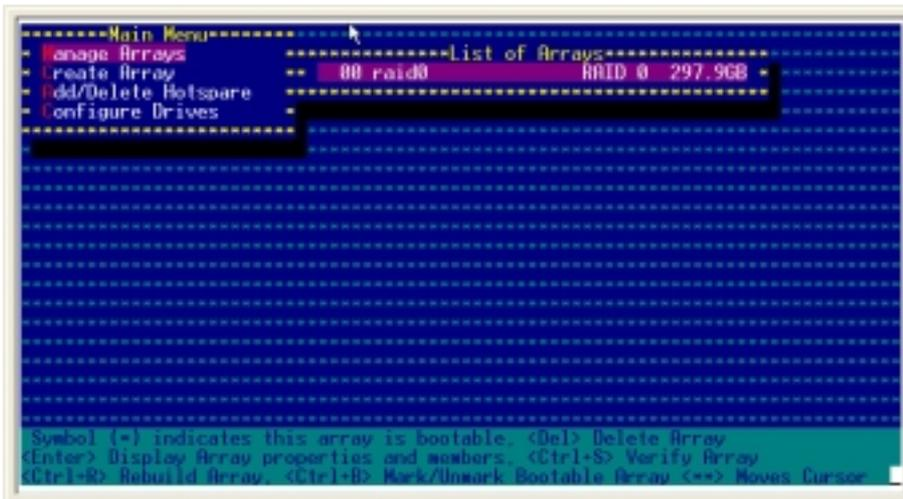

3. From the array properties dialog box, select **[Delete]**, then press <Enter>.

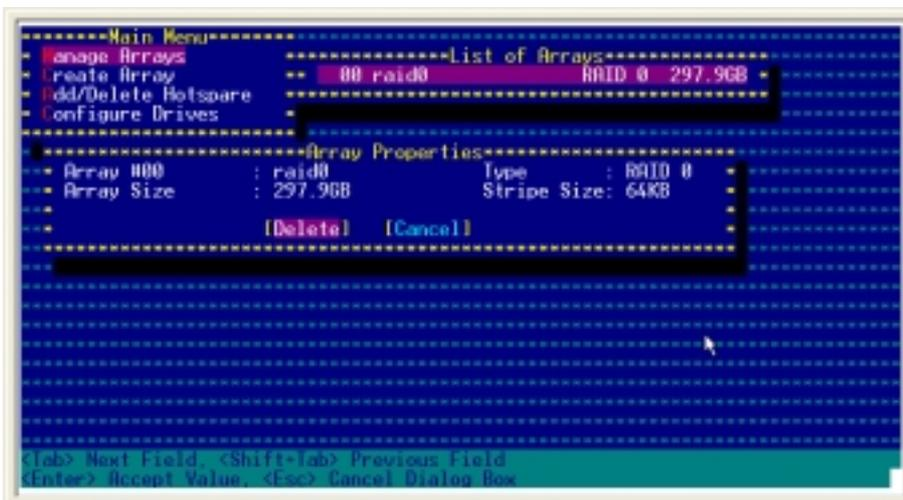

4. A warning message appears on screen. Press <Y> to delete the array, or press <N> to abort.



5. A **No Arrays present** message appears on screen. Press any key to continue.



5.5.6 Deleting a RAID 1 set

To delete a RAID 1 set:

1. From the Adaptec RAID Configuration Utility initial menu, highlight **Array Configuration Utility**, then press <Enter>.
2. Select **Manage Array** from the Main Menu, then select the array that you want to delete. Press <Enter> when finished.

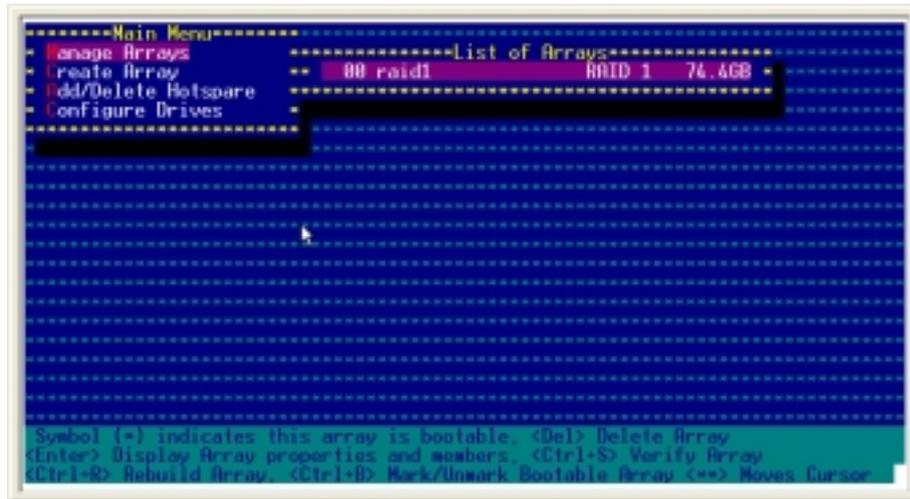

3. From the array properties dialog box, select **[Delete]**, then press <Enter>.

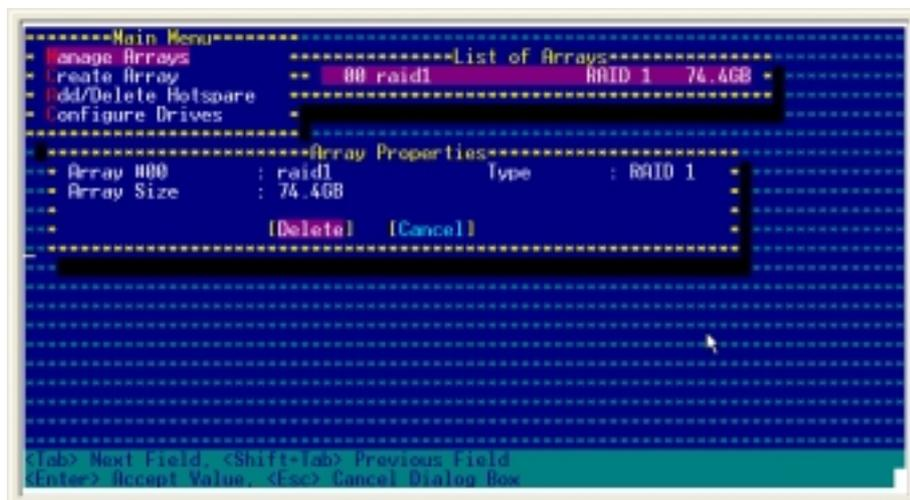

4. A warning message appears on screen. Press <Y> to delete the array, or press <N> to abort.



5. A **Deleting Information** dialog box appears. Select **[None]** to preserve the partition table after deleting the array. Select either **[Member#0]**, **[Member#1]**, or **[Both]** to delete the partition table on one or both member drives.

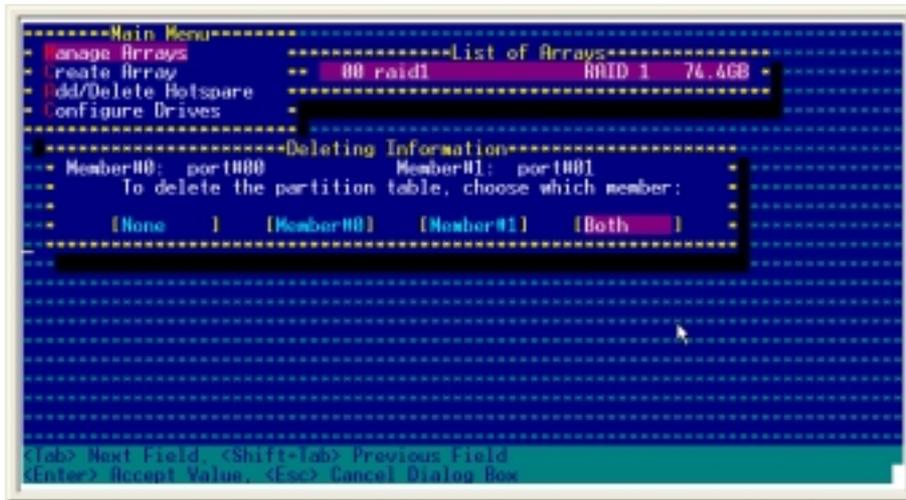

6. Press <Enter> to delete the array.
7. A **No Arrays present** message appears on screen. Press any key to continue.



5.5.7 Adding a spare drive to a RAID 1 set

To add a spare drive to a RAID 1 set:

1. From the Adaptec RAID Configuration Utility initial menu, highlight **Array Configuration Utility**, then press <Enter>.
2. Select **Add/Delete Hotspare** from the Main Menu, then press <Enter>.

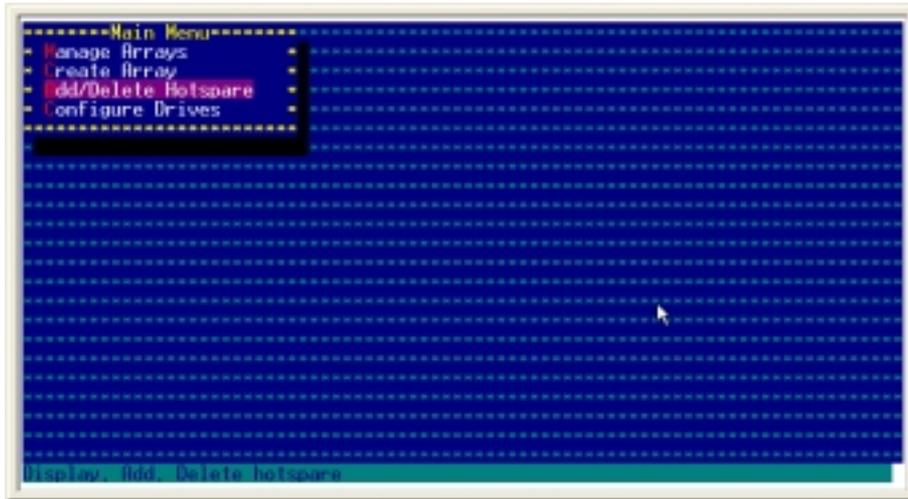

3. Select the spare drive from the list, then press <Insert>. The selected drive appears in the **Assigned Hotspare drives** section. Press <Enter> when finished.

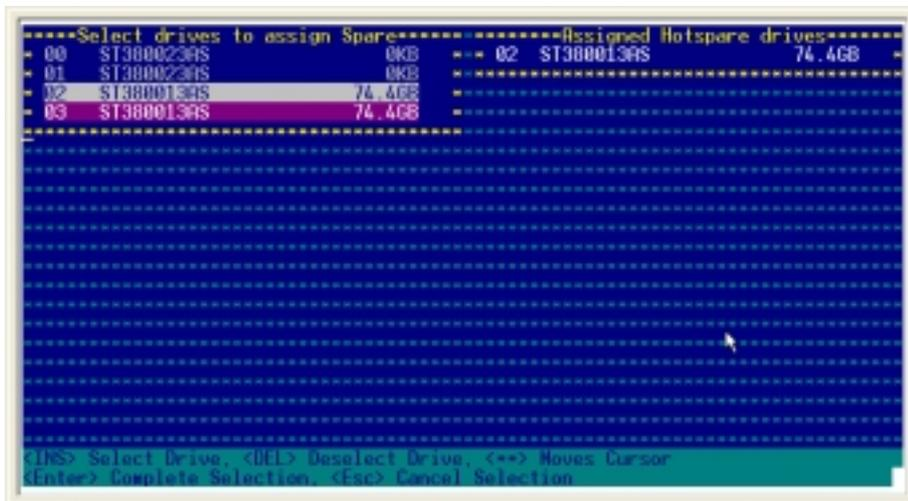

4. When prompted, press <Y> to create the spare, or press <N> to abort.



5.5.8 Deleting a RAID 1 spare drive

To delete a RAID 1 spare drive:

1. From the Adaptec RAID Configuration Utility initial menu, highlight **Array Configuration Utility**, then press <Enter>.
2. Select **Add/Delete Hotspare** from the Main Menu, then press <Enter>.

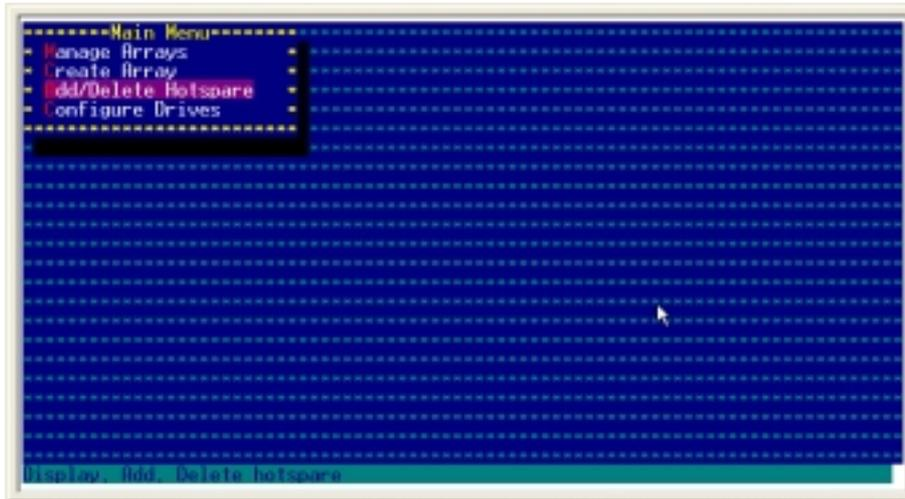

3. Select the spare drive you want to delete, then press <Insert>. Press <Enter> when finished.

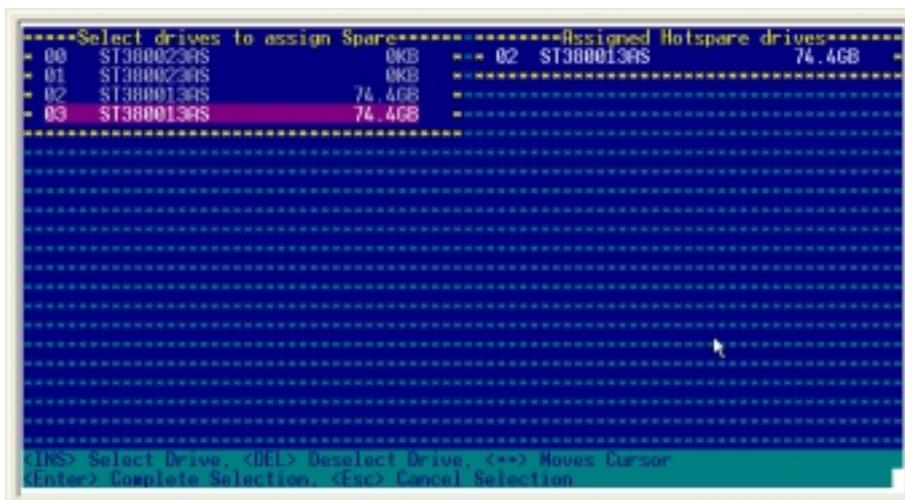

4. When prompted, press <Y> to delete the spare, or press <N> to abort.



5.5.9 Rebuilding a RAID set

The utility displays the condition of the RAID set during the POST. When a RAID set is degraded, you can use the utility to rebuild it.



- You may only rebuild Fault Tolerant arrays (RAID 1).
- If no spare exists and a hard disk drive fails, you need to create a spare before you can rebuild an array.
- By replacing a failed drive of a RAID 1 array with a new drive, you can rebuild to get the array to optimal status and assume fault tolerance.

There are two ways to rebuild a RAID set: system shutdown rebuild and manual rebuild. Refer to the sections below for details.

System shutdown rebuild

When a RAID set drive fails or an array gets degraded, shut down the system and replace the failed drive with a new one (of equal or greater capacity). When you reboot the system, you can assign the new drive as a spare, and automatically start the rebuild process. The existing drive data is copied to the new one, and the original RAID 1 array is recreated.

Manual rebuild

To manually rebuild a RAID set:

1. Select **Manage Arrays** from the Main Menu, then press <Enter> to display the list of arrays.

```
*****Main Menu*****
Manage Arrays
Create Array
Add/Delete Hotspare
Configure Drives

*****List of Arrays*****
** 00 r1 RAID 1 74.4GB **

Symbol (*) indicates this array is bootable. <Del> Delete Array
<Enter> Display Array properties and members. <Ctrl-S> Verify Array
<Ctrl-R> Rebuild Array. <Ctrl-B> Mark/Unmark Bootable Array <==> Moves Cursor
```

2. Select the array that you want to rebuild from the list of arrays, then press <Enter> to display the array properties.

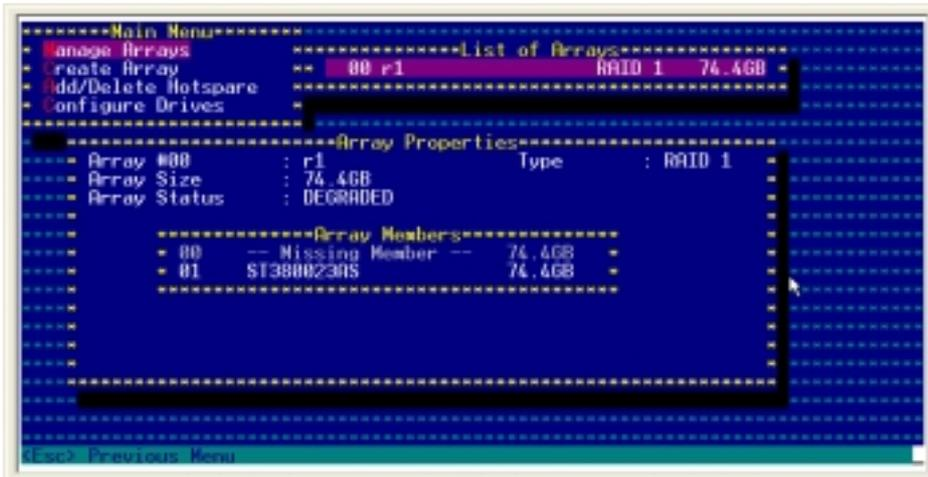

3. Press <Ctrl> + <R> to start rebuilding the array. You can check the rebuilding progress in the Array Properties window.

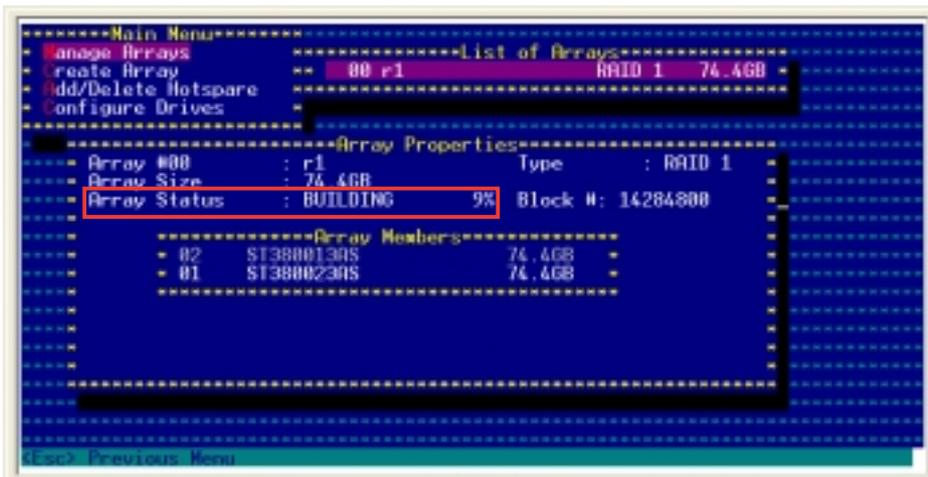

5.5.10 Using the Disk Utilities

The **Disk Utilities** option allows you to format and/or verify the consistency of the hard disk drives.

To format or verify the hard disk drives using the Disk Utilities:

1. Select Disk Utilities from the Adaptec® RAID Configuration Utility initial menu, then press <Enter>.

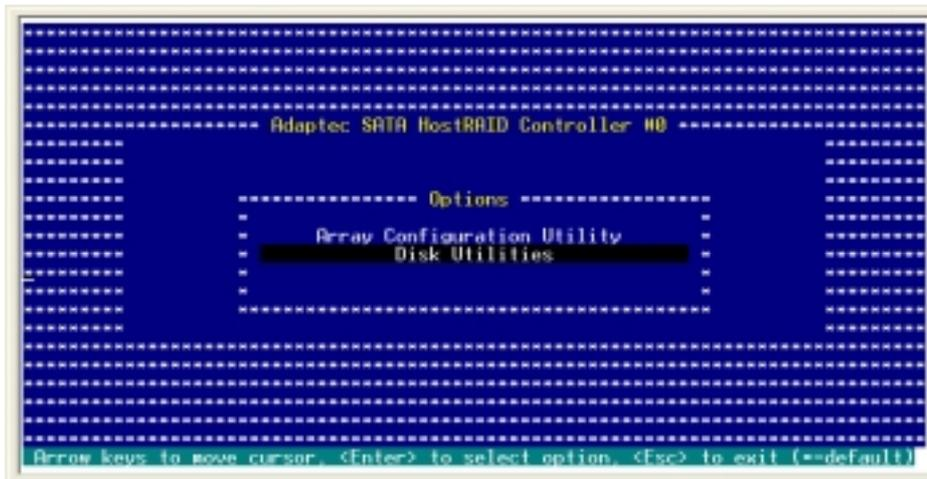

2. Select the drive that you want to format or verify, then press <Enter>.

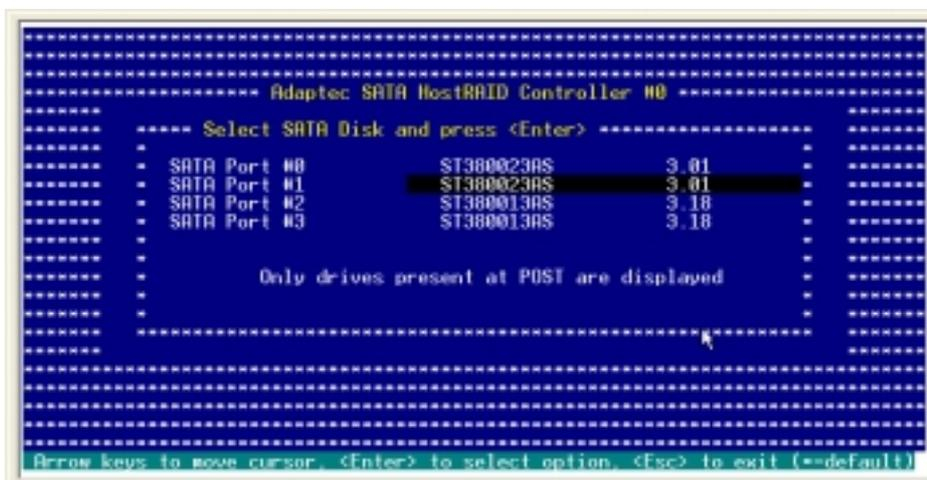

3. Select **Format Disk** or **Verify Disk Media** from the menu, then press <Enter>. Refer to the options description below.

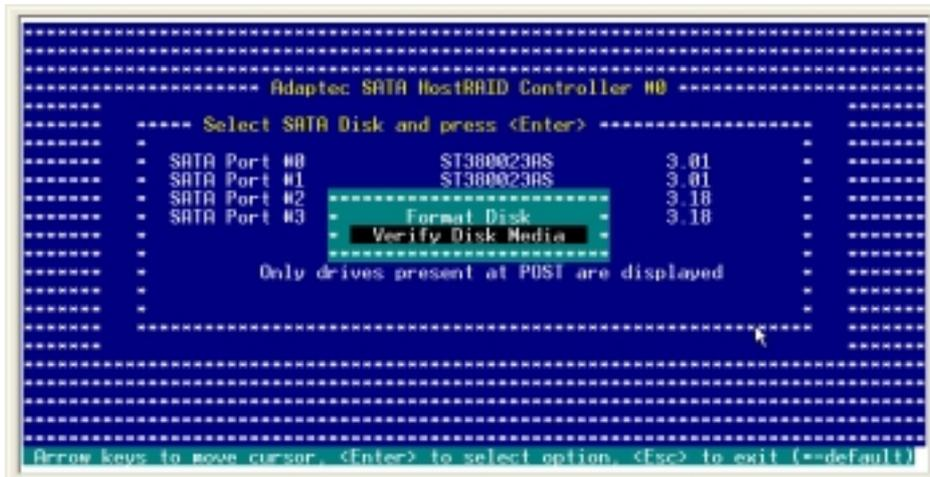

Format Disk

- The utility performs a low-level format on the drive. By default, SATA hard disk drives are low-level formatted at the factory and do not need to be low-level formatted again.



Formatting erases all data on the hard disk drive!

Verify Disk Media

- Performs a scan on the media of the drive for defects.

4. Follow screen instructions to proceed.

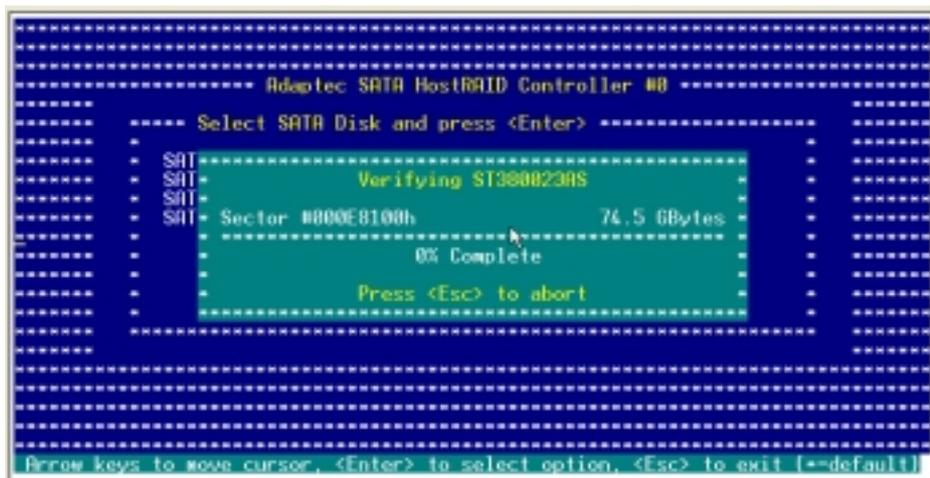

This chapter provides instructions for installing the necessary drivers for various system components.

6 Driver installation

Chapter summary



6.1	RAID driver installation	6-1
6.2	LAN driver installation	6-10
6.3	VGA driver installation	6-14
6.4	Management applications and utilities installation	6-16

6.1 RAID driver installation

After creating the RAID sets for your server system, you are now ready to install an operating system to the independent hard disk drive or bootable array. This part provides instructions on how to install the RAID controller drivers during OS installation.

6.1.1 Creating a RAID driver disk



You may have to use another system to create the RAID driver disk from the system/motherboard support CD or from the Internet.

Windows® 2000/2003 Server

A floppy disk with the RAID driver is required when installing Windows® 2000/2003 Server operating system on a hard disk drive that is assigned to an array.

To create a RAID driver disk from Windows® environment:

1. Place the system or motherboard support CD in the optical drive.
2. When the **Drivers** menu appears, select the RAID driver disk you want to create.

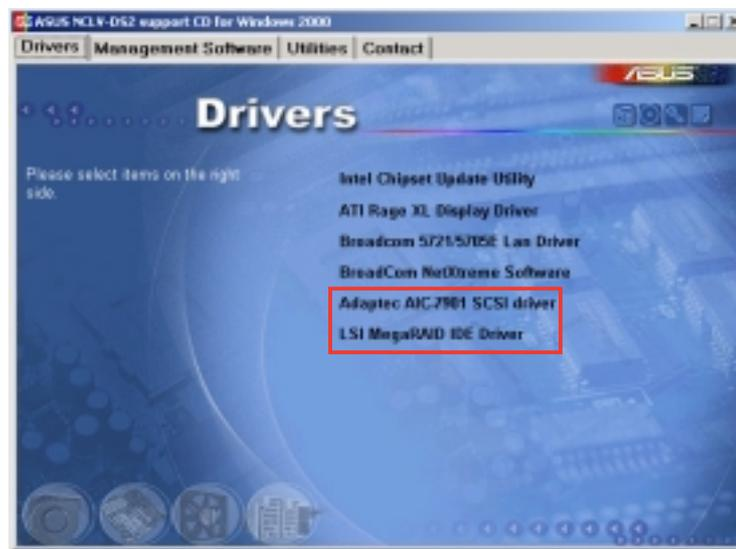

OR

Browse the contents of the support CD to locate the driver disk utility.

3. Insert a formatted high-density floppy disk to the floppy disk drive.
4. Follow screen instructions to complete the process.
5. After creating a RAID driver disk, eject the floppy disk, then write-protect it to prevent computer virus infection.

Red Hat® Enterprise ver. 3.0

To create a RAID driver disk for Red Hat® Enterprise ver. 3.0 system:

1. Insert a blank formatted high-density floppy disk to the floppy disk drive.
2. Decompress the zipped file into the floppy disk from the following path in the support CD:

For **Intel® 6300ESB** RAID driver disk:

```
\Drivers\6300ESB\Driver\Linux\  
dud-rh30-megaide-v5.08u-generic-1.img
```

For **Adaptec® AIC-8130** RAID driver disk (NCLV-D2/SATA model only):

```
\Drivers\Adaptec\HostRAID\driver\Linux\  
a320raid-3.00.056.V580-1.rhel3qu3.i686.img
```

For **Adaptec® AIC-7901X** RAID driver disk (NCLV-DS2 model only):

```
\Drivers\Adaptec\SCSI\Driver\Linux 2.0.12\  
aic79xx-2.0.12-i686-rhel3.img
```

3. Eject the floppy disk.

6.1.2 Installing the RAID controller driver

Windows® 2000/2003 Server OS

During Windows® 2000/2003 Server OS installation

To install the RAID controller driver when installing Windows® 2000/2003 Server OS:

1. Boot the computer using the Windows® 2000/2003 Server installation CD. The **Windows® 2000/2003 Setup** starts.



2. Press <F6> when the message “**Press F6 if you need to install a third party SCSI or RAID driver...**” appears at the bottom of the screen.
3. When prompted, press <S> to specify an additional device.

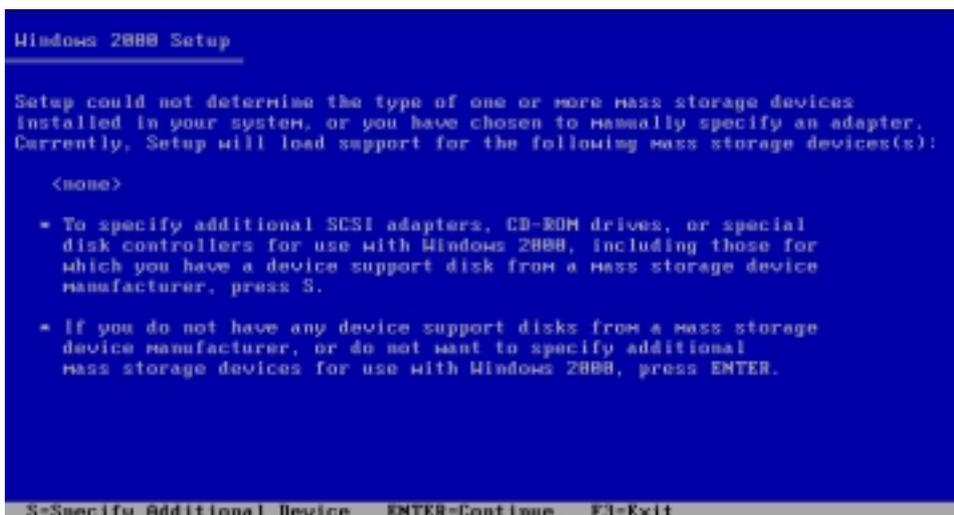

4. Insert the RAID driver disk you created earlier to the floppy disk drive, then press <Enter>.

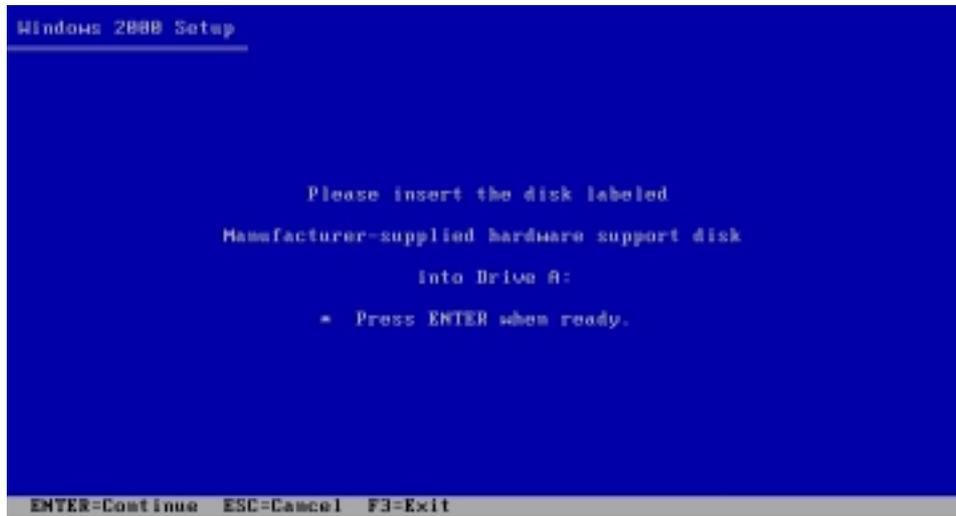

5. Select the RAID controller driver from the list, then press <Enter>.

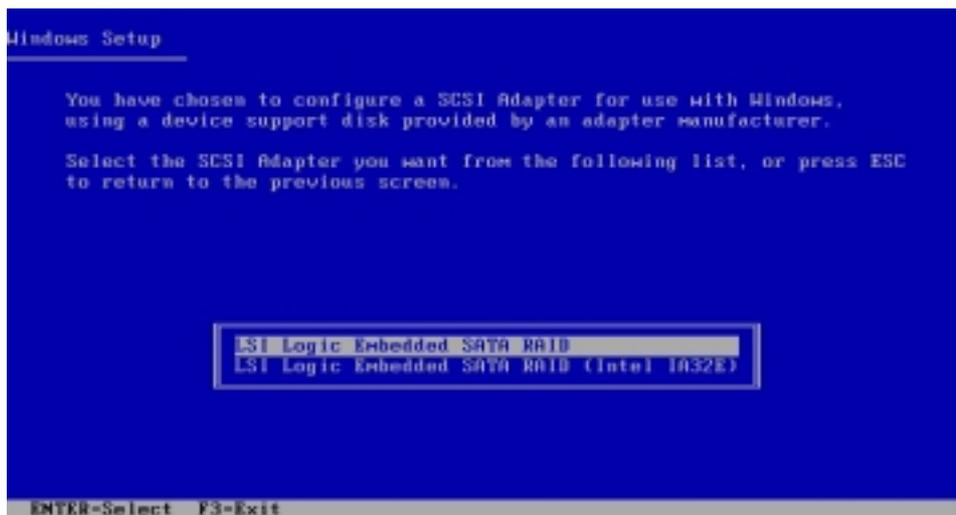

- For Intel® 6300ESB LSI Logic Embedded SATA RAID driver, select LSI Logic Embedded SATA RAID.
 - For Adaptec® AIC-8130 SATA RAID driver, select Adaptec Embedded Serial ATA HostRAID Controller.
 - For Adaptec® AIC-7901X SCSI RAID driver, select Adaptec HostRAID U320 Diver ver. 1.02 for Windows 2000/XP/2003.
6. The Windows® 2000/2003 Setup loads the RAID controller drivers from the RAID driver disk. When prompted, press <Enter> to continue installation.
 7. Setup then proceeds with the OS installation. Follow screen instructions to continue.

To an existing Windows® 2000/2003 Server OS

To install the RAID controller driver on an existing Windows® 2000/2003 Server OS:

1. Restart the computer, then log in with **Administrator** privileges.
2. Windows® automatically detects the RAID controller and displays a **New Hardware Found** window. Click **Cancel**.
3. Right-click the **My Computer** icon on the Windows® desktop , then select **Properties** from the menu.
4. Click the **Hardware** tab, then click the **Device Manager** button to display the list of devices installed in the system.

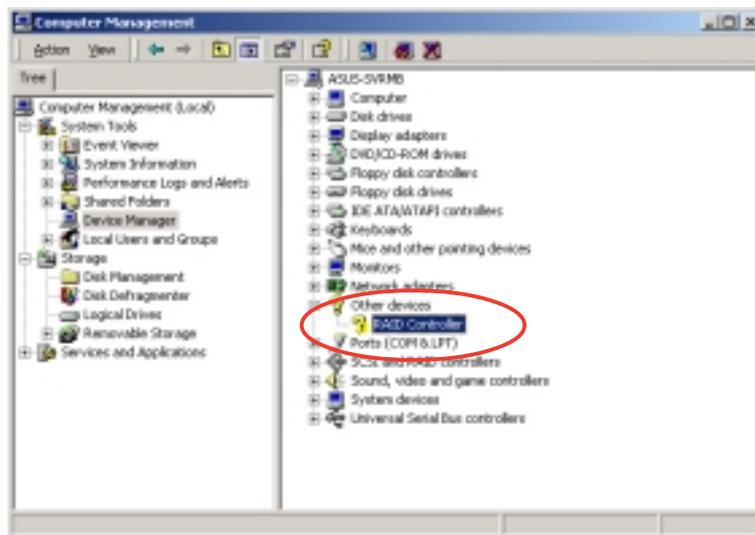

5. Right-click the **RAID controller** item, then select **Properties**.
6. Click the **Driver** tab, then click the **Update Driver** button.
7. The **Upgrade Device Driver Wizard** window appears. Click **Next**.
8. Insert the RAID driver disk you created earlier to the floppy disk drive.
9. Select the option “**Search for a suitable driver for my device (recommended)**”, then click **Next**.
10. The wizard searches the RAID controller drivers. When found, click **Next** to install the drivers.
11. Click **Finish** after the drivers installation is done.

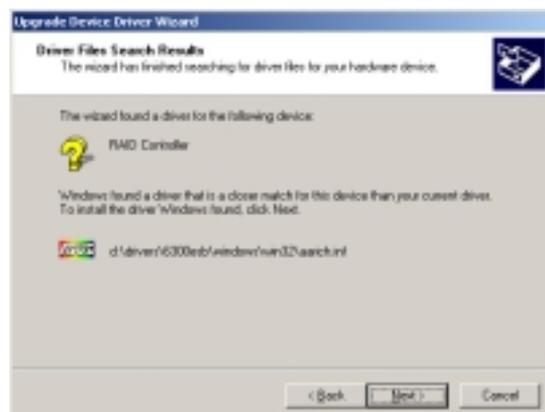

To verify the RAID controller driver installation:

1. Right-click the **My Computer** icon on the Windows® desktop , then select **Properties** from the menu.
2. Click the **Hardware** tab, then click the **Device Manager** button.
3. Click the “+” sign before the item **SCSI and RAID controllers**.

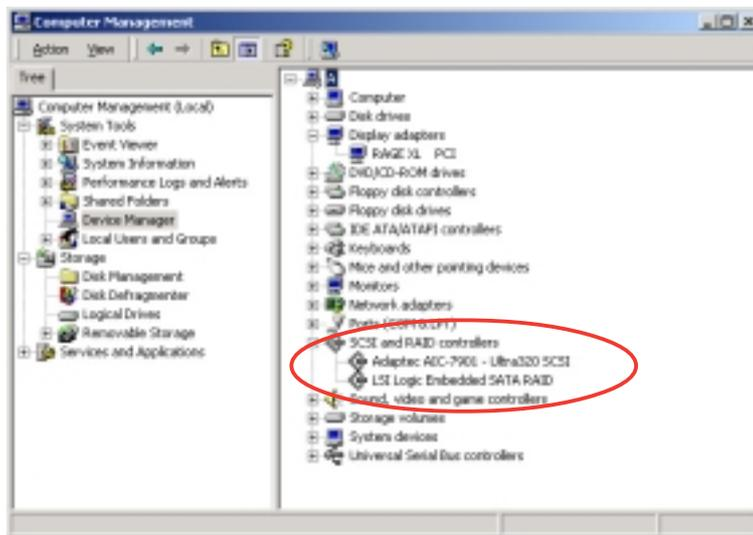

- For both models, the **LSI Logic Embedded SATA RAID** item should appear.
 - For NCLV-DS2 model, the **LSI Logic Embedded SATA RAID** and **Adaptec AIC-7901 - Ultra320 SCSI** items should appear.
 - For NCLV-D2/SATA model, the **LSI Logic Embedded SATA RAID** and **Adaptec Embedded Serial ATA HostRAID Controller** item should appear.
4. Right-click the RAID controller driver item, then select **Properties** from the menu.
 5. Click the **Driver** tab, then click the **Driver Details** button to display the RAID controller drivers.
 6. Click **OK** when finished.

Red Hat® Enterprise ver. 3.0

To install the Intel® 6300ESB LSI Logic Embedded SATA RAID controller driver when installing a Red Hat® Enterprise ver. 3.0 operating system:

1. Boot the system from the Red Hat® Installation CD.

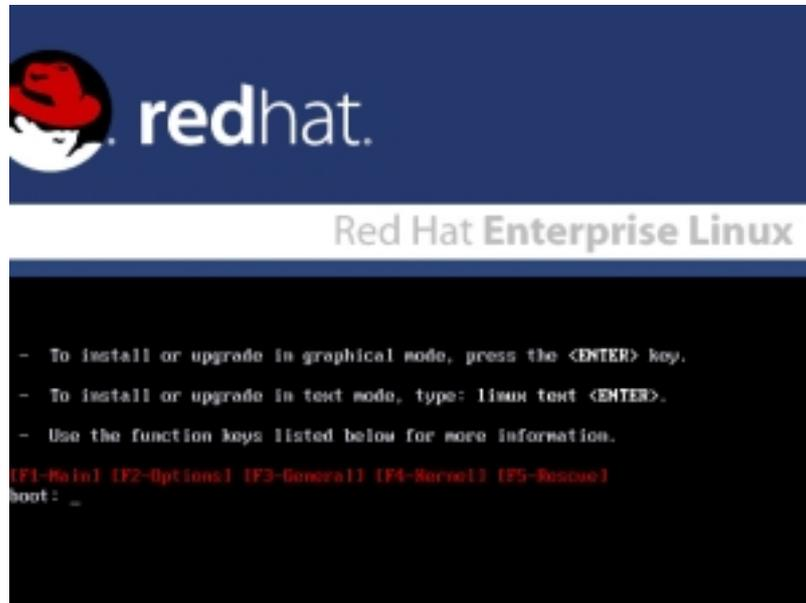

2. At the boot:, type `linux dd` , then press <Enter>.

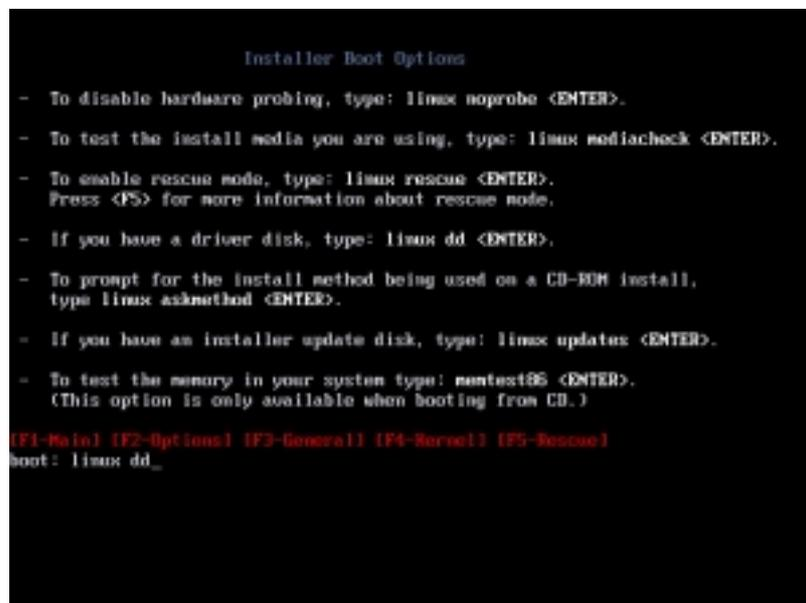

3. Select **Yes** using the <Tab> key when asked if you have the driver disk. Press <Enter>

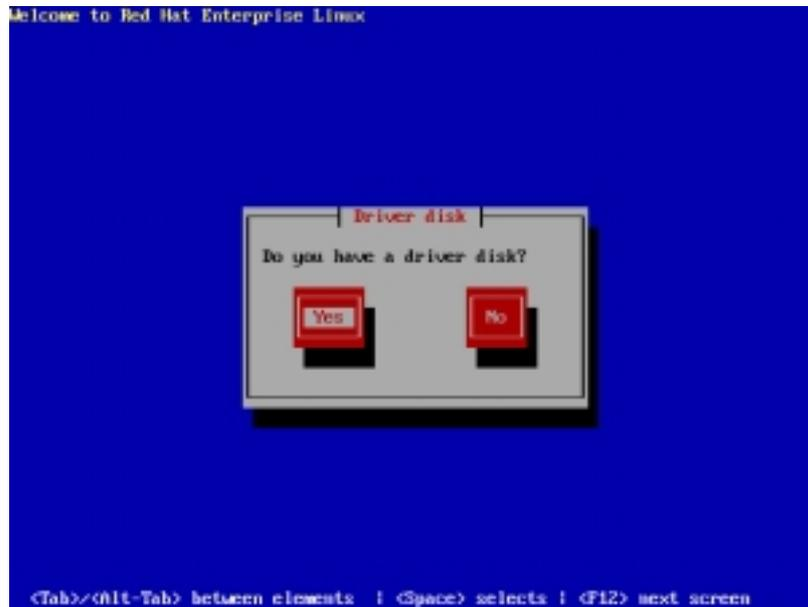

4. Select **fd0** using the <Tab> key when asked to select the driver disk source. Press <Tab> to move the cursor to **OK**, then press <Enter>.

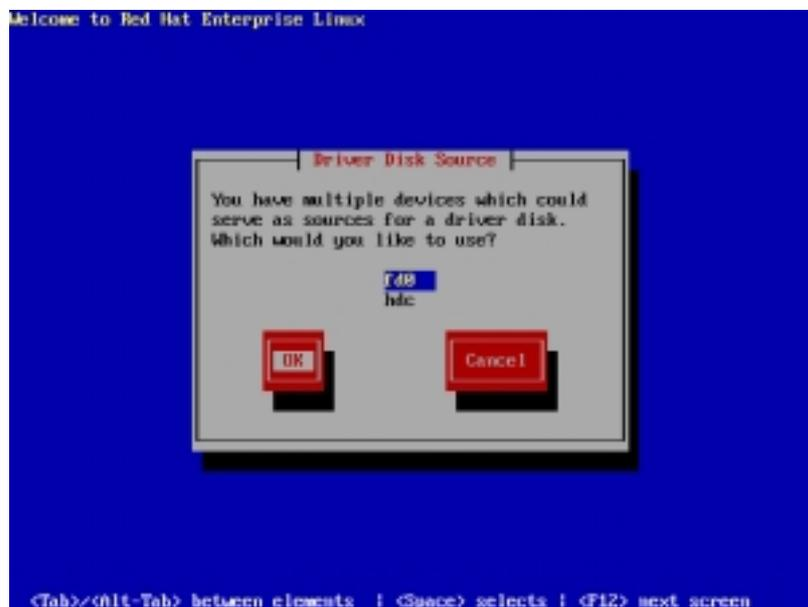

5. When prompted, insert the Red Hat® Enterprise ver. 3.0 RAID driver disk to the floppy disk drive, select **OK**, then press <Enter>.

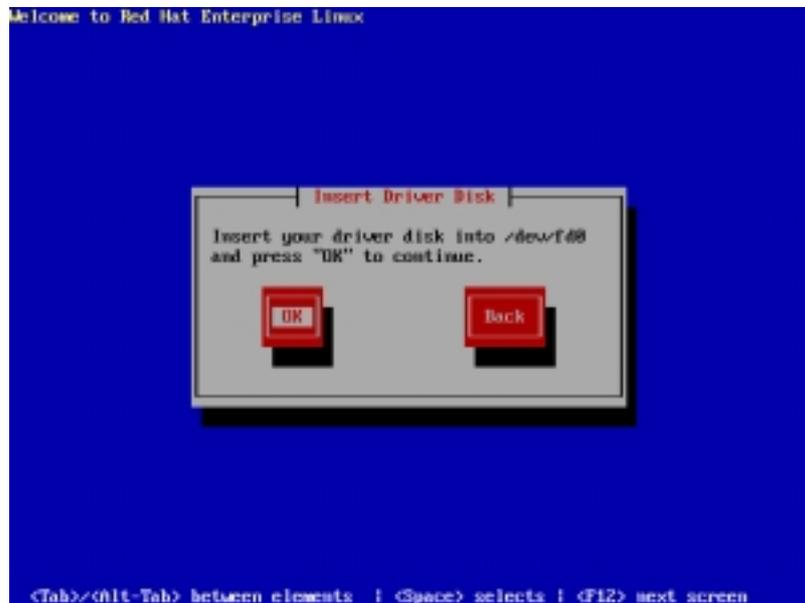

The drivers for the RAID controller are installed to the system.

6. When asked if you will load additional RAID controller drivers:
 - For NCLV-DS2 model, select **Yes**, then install the additional RAID controller drivers for the Adaptec® AIC-7901X.
 - For NCLV-D2/SATA model, select **Yes**, then install the additional RAID controller drivers for the Adaptec® AIC-8130.

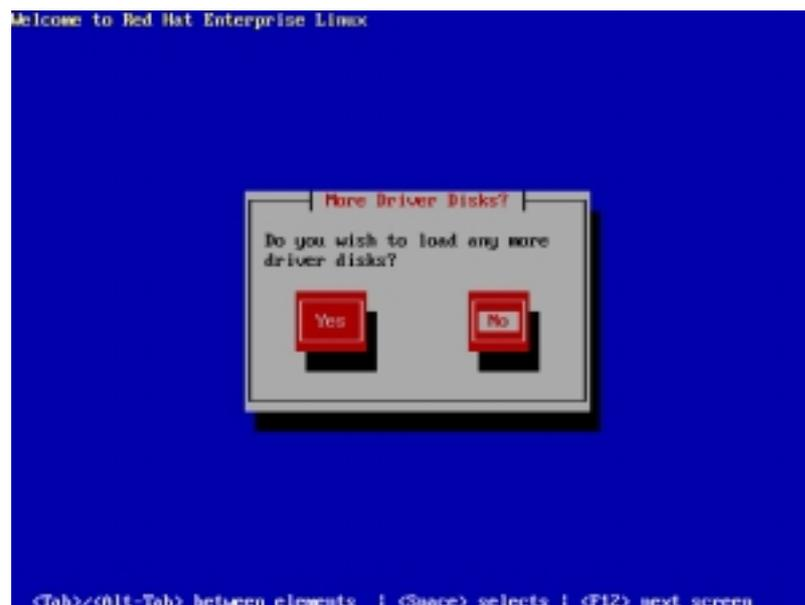

7. Follow screen instructions to continue the OS installation.

6.2 LAN driver installation

This section provides instructions on how to install the Broadcom® Gigabit LAN controller drivers.

6.2.1 Windows® 2000/2003 Server

To install the Broadcom® Gigabit LAN controller driver on a Windows® 2000/2003 Server OS:

1. Restart the computer, then log on with **Administrator** privileges.
2. Insert the motherboard/system support CD to the optical drive. The CD automatically displays the **Drivers** menu if Autorun is enabled in your computer.



- Windows® automatically detects the LAN controllers and displays a **New Hardware Found** window. Click **Cancel** to close this window.
- If **Autorun** is NOT enabled in your computer, browse the contents of the support CD to locate the file ASSETUP.EXE from the BIN folder. Double-click the **ASSETUP.EXE** to run the CD.

3. Click the **Broadcom 5721/5705E LAN Driver** option to begin installation.

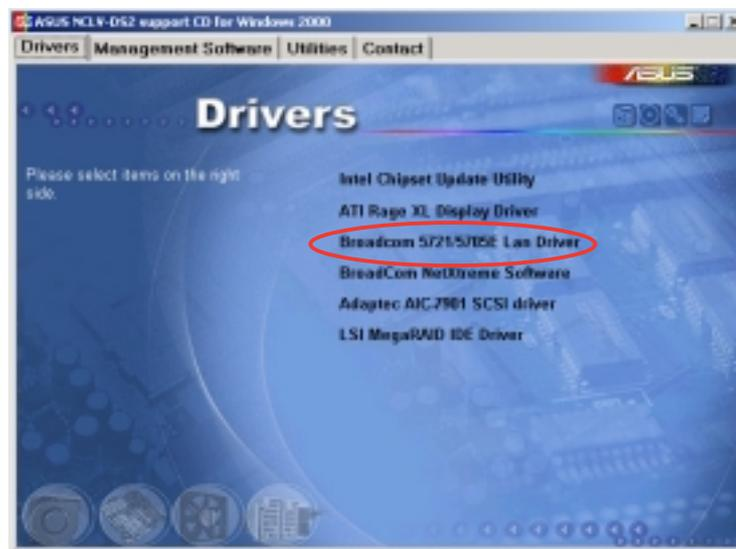

4. Click **Next** when the InstallShield Wizard window appears. Follow screen instructions to continue installation.

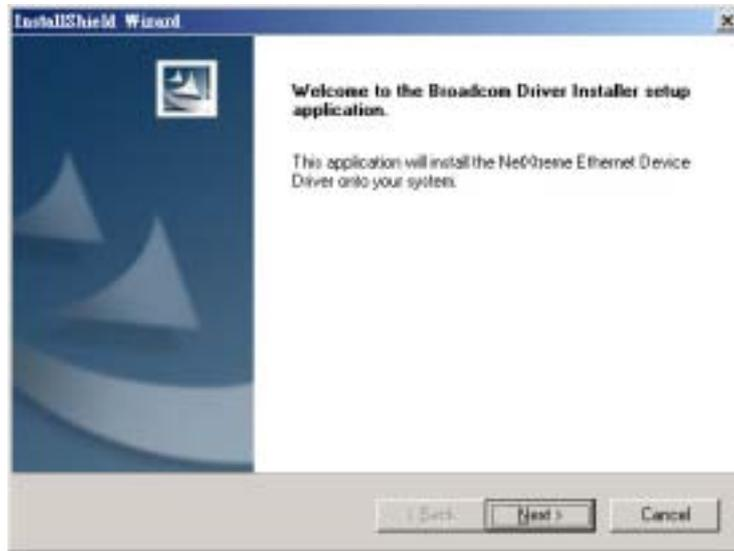

6.2.2 Red Hat® Enterprise ver. 3.0

Follow these instructions when installing the Broadcom® Gigabit LAN controller base driver for the Red Hat® Enterprise ver. 3.0 operating system.

Installing the source RPM package

To install the source RPM package:

1. Install the source RPM package:

```
rpm -ivh bcm5700-<version>.src.rpm
```
2. Change the directory to the RPM path and build the binary driver for your kernel:

```
cd /usr/src/{redhat,OpenLinux,turbo,packages,rpm ..}  
rpm -bb SPECS/bcm5700.spec or rpmbuild -bb SPECS/  
bcm5700.spec
```



The RPM path is different for different Linux distributions.

3. Install the newly built package (driver and man page):

```
rpm -ivh RPMS/i386/bcm5700-<version>.i386.rpm
```



You need the force option when installing the driver on some distributions that has an older version of the driver.

For **2.2.x kernels**, the driver is installed in:

```
/lib/modules/<kernel_version>/net/bcm5700.o
```

For **2.4.x kernels**, the driver is installed in:

```
/lib/modules/<kernel_version>/kernel/drivers/net/  
bcm5700.o
```

For **2.4.x kernels with bcm5700 driver patched in**, the driver is installed in:

```
/lib/modules/<kernel_version>/kernel/drivers/net/bcm/  
bcm5700.o
```

or

```
/lib/modules/<kernel_version>/kernel/drivers/addon/  
bcm5700/bcm5700.o
```

4. Load the driver:

```
insmod bcm5700
```
5. Refer to Linux distribution documentation to configure the network protocol and address.

Building the driver from the TAR file

To build the driver from the TAR file:

1. Create a directory and extract the TAR files:
`tar xvzf bcm5700-<version>.tar.gz`
2. Build the driver `bcm5700.o` as a loadable module for the running kernel:
`cd bcm5700-<version>/src`
`make`
3. Test the driver by loading it:
`insmod bcm5700.o`
4. Install the driver and man page:
`make install`



See the RPM instructions on the previous page for the location of the installed driver.

5. Refer to Red Hat distribution documentation to configure the network protocol and address.

6.3 VGA driver installation

This section provides instructions on how to install the ATI® RAGE XL Video Graphics Adapter (VGA) driver.

6.3.1 Windows® 2000 Server

You need to manually install the ATI® RAGE XL VGA driver on a Windows® 2000 Server operating system.

To install the ATI® RAGE XL VGA driver:

1. Restart the computer, then log on with **Administrator** privileges.
2. Insert the motherboard/system support CD to the optical drive. The support CD automatically displays the **Drivers** menu if Autorun is enabled in your computer.



Windows® automatically detects the LAN controller and displays a **New Hardware Found** window. Click **Cancel** to close this window.

3. Click the item **ATI Rage XL Display Driver** from the **Drivers** menu.

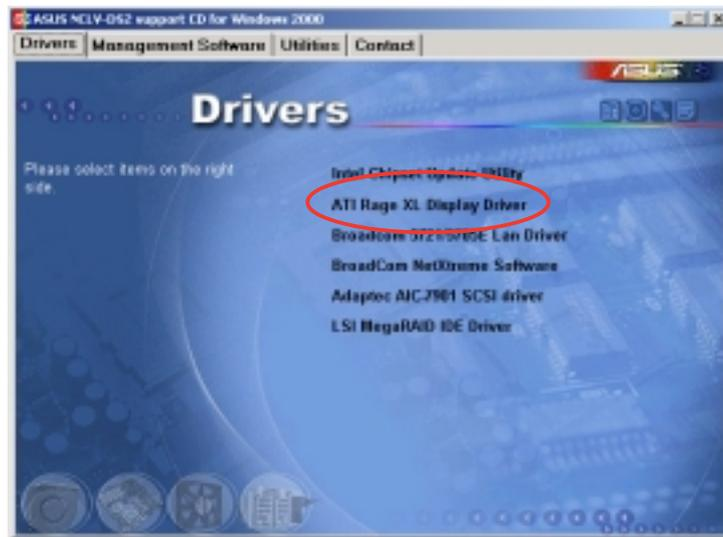

4. The **ATI Windows 2000 Driver** window appears. Click **Next**. Follow screen instructions to complete installation.

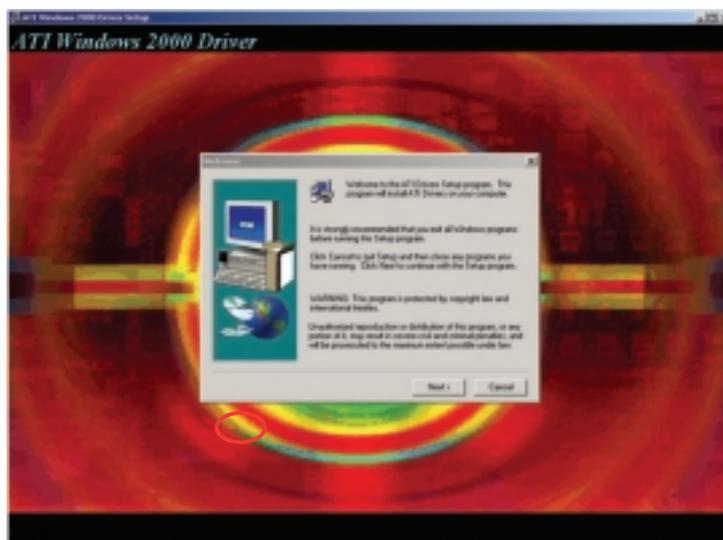

6.3.2 Windows® 2003 Server

The Windows® 2003 Server operating system automatically recognizes the ATI® RAGE XL VGA driver during system installation. There is no need to install an additional driver(s) to support the onboard VGA.

6.3.3 Red Hat® Enterprise ver. 3.0

The Red Hat® Enterprise ver. 3.0 operating system automatically recognizes the ATI® RAGE XL VGA driver during system installation. There is no need to install an additional driver(s) to support the onboard VGA.

6.4 Management applications and utilities installation

The support CD that came with the motherboard package contains the drivers, management applications, and utilities that you can install to avail all motherboard features.



The contents of the support CD are subject to change at any time without notice. Visit the ASUS website (www.asus.com) for updates.

6.4.1 Running the support CD

Place the support CD to the optical drive. The CD automatically displays the **Drivers** menu if Autorun is enabled in your computer.



If **Autorun** is NOT enabled in your computer, browse the contents of the support CD to locate the file **ASSETUP.EXE** from the BIN folder. Double-click the **ASSETUP.EXE** to run the CD.

6.4.2 Drivers menu

The **Drivers** menu shows the available device drivers if the system detects installed devices. Install the necessary drivers to activate the devices.



The screen display and driver options vary under different operating system versions.

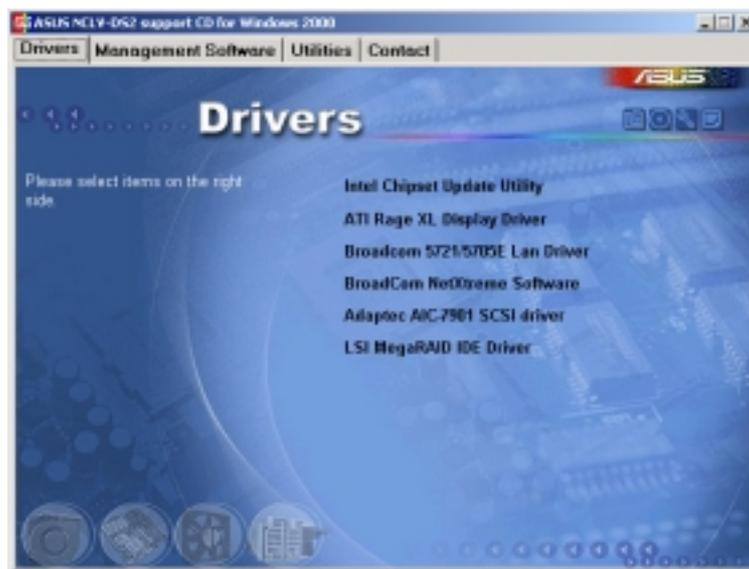

6.4.3 Management Software menu

The **Management Software** menu displays the available network and server monitoring applications. Click on an item to install.



6.4.4 Utilities menu

The **Utilities** menu displays the software applications and utilities that the motherboard supports. Click on an item to install.

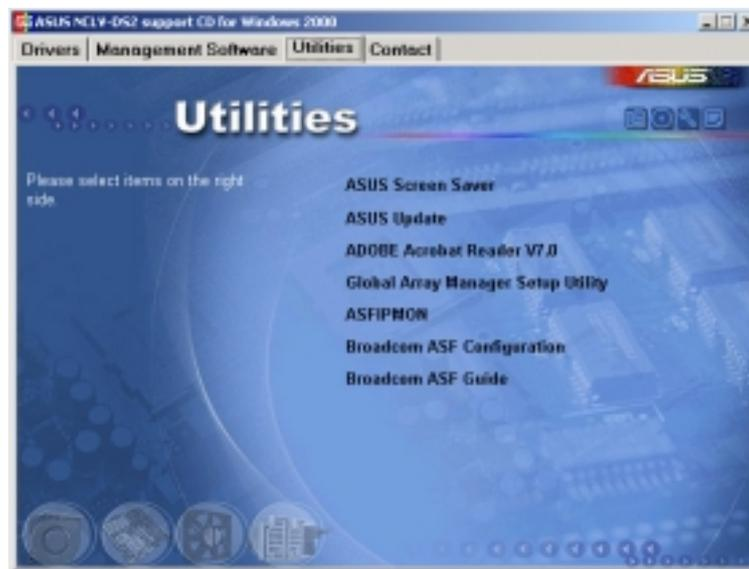

6.4.5 Contact information

Click the **Contact** tab to display the ASUS contact information. You can also find this information on the inside front cover of this user guide.

This appendix includes additional information that you may refer to when configuring the motherboard.

Reference information

Appendix summary



A.1	NCLV-D2/SATA block diagram	A-1
A.2	NCLV-DS2 block diagram	A-2

A.1 NCLV-D2/SATA block diagram

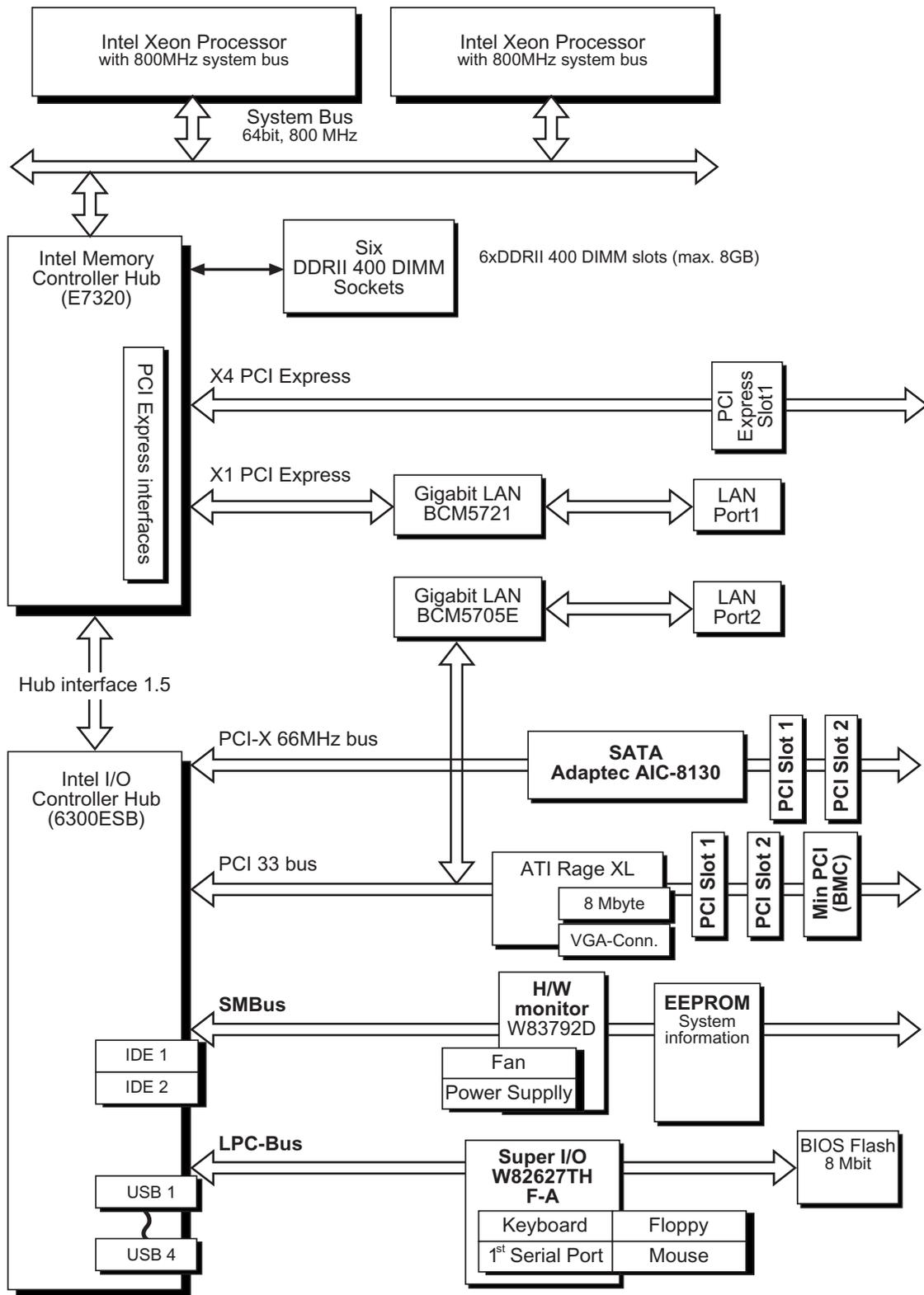

A.2 NCLV-DS2 block diagram

